

**FS40**

**SocketA**

**AMD Athlon/Duron Processor**

**Based DDR MAIN BOARD**

*User's Manual*

# WARNING

Thermal issue is highly essential for processors with a speed of 600MHz and above. Hence, we recommend you to use the CPU fan qualified by AMD or motherboard manufacturer. Meanwhile, please make sure CPU and fan are securely fastened well. Otherwise, improper fan installation not only gets system unstable but also could damage both CPU and motherboard because insufficient thermal dissipation.

If you would like to know more about thermal topic please see **AMD website** for detailed thermal requirement through the address:

**<http://www.amd.com/products/athlon/thermals>**

**<http://www.amd.com/products/duron/thermals>**

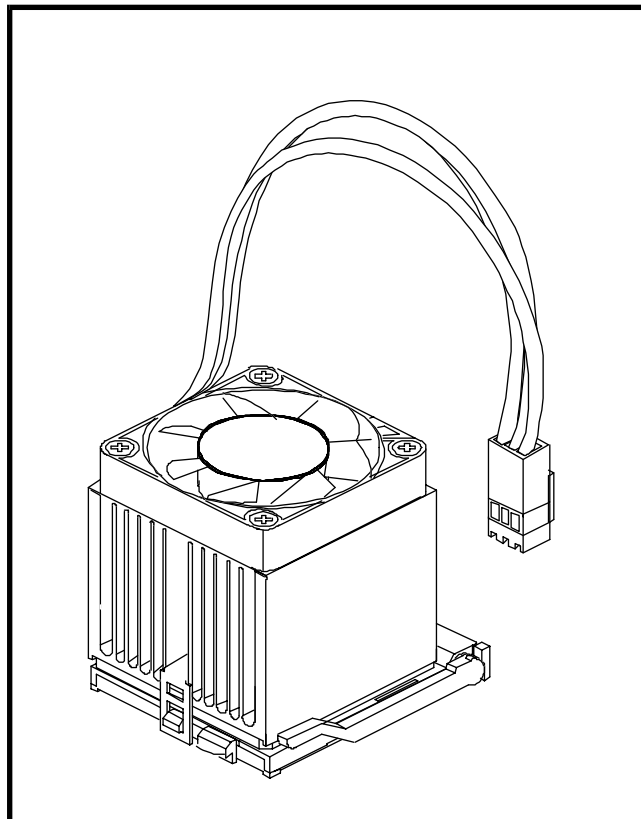

# Shuttle® Spacewalker™ FS40

SocketA

AMD Athlon/Duron Processor

based DDR Mainboard

Manual Version 1.0

## Copyright

Copyright© 2002 by Shuttle® Inc. All Rights Reserved.

No part of this publication may be reproduced, transcribed, stored in a retrieval system, translated into any language, or transmitted in any form or by any means, electronic, mechanical, magnetic, optical, chemical, photocopying, manual, or otherwise, without prior written permission from Shuttle® Inc.

## Disclaimer

Shuttle® Inc. shall not be liable for any incidental or consequential damages resulting from the performance or use of this product.

This company makes no representations or warranties regarding the contents of this manual. Information in this manual has been carefully checked for reliability; however, no guarantee is given as to the correctness of the contents. In the interest of continued product improvement, this company reserves the right to revise the manual or include changes in the specifications of the product described within it at any time without notice and without obligation to notify any person of such revision or changes. The information contained in this manual is provided for general use by the customers.

## Trademarks

Spacewalker is a registered trademark of Shuttle Inc.

AMD, Athlon, and Duron are registered trademarks of AMD Corporation.

SiS is a registered trademark of SiS Corporation.

PS/2 is a registered trademark of IBM Corporation.

AWARD is a registered trademark of Award Software Inc.

Microsoft and Windows are registered trademarks of Microsoft Corporation.

**General Notice:** Other brand and product names used herein are for identification purposes only and may be trademarks of their respective owners.

# TABLE OF CONTENTS

---

<b>WHAT'S IN THE MANUAL .....</b>	<b>5</b>
<b>Quick Reference .....</b>	<b>5</b>
<b>About This Manual .....</b>	<b>5</b>
<b>1 INTRODUCTION .....</b>	<b>6</b>
<b>1.1 TO DIFFERENT USERS .....</b>	<b>6</b>
FIRST-TIME DIY SYSTEM BUILDER .....	6
EXPERIENCED DIY USER .....	6
SYSTEM INTEGRATOR .....	6
<b>1.2 ITEM CHECKLIST: .....</b>	<b>7</b>
<b>2 FEATURES .....</b>	<b>8</b>
<b>2.1 SPECIFICATIONS .....</b>	<b>8</b>
<b>3 HARDWARE INSTALLATION .....</b>	<b>11</b>
<b>3.1 STEP BY STEP INSTALLATION .....</b>	<b>11</b>
Accessories of FS40 .....	11
STEP 1 Install the CPU .....	12
STEP 2 Set Jumpers .....	13
STEP 3 Install DDR SDRAM System Memory .....	13
STEP 4 Install Peripherals in System Case .....	14
STEP 5 Mount the Mainboard on the Computer Chassis .....	15
STEP 6 Connect Front Panel Switches/LEDs/Speaker/USB .....	16
STEP 7 Connect IDE and Floppy Disk Drives .....	17
STEP 8 Connect Other Internal Peripherals .....	17
STEP 9 Connect the Power Supply .....	18
STEP 10 Install Add-on Cards in Expansion Slots .....	18
STEP 11 Connect External Peripherals to Back Panel .....	19
STEP 12 First Time System Boot Up .....	20
STEP 13 Install Drivers & Software Components .....	21

---

<b>3.2 JUMPER SETTINGS .....</b>	<b>22</b>
JUMPERS & CONNECTORS GUIDE .....	23
<b><i>Jumpers</i></b>	
Clear CMOS Setting (JP1) .....	26
<b><i>Back-Panel Connectors</i></b>	
COM1/2 Port Connectors .....	27
VGA Port Connector .....	27
Optional AV & S Video TV-Out Connectors .....	27
IEEE 1394 Port Connectors .....	27
10/100 base-T LAN Port Connector .....	27
USB0/1 Port Connectors .....	28
PS/2 Keyboard & PS/2 Mouse Connectors .....	28
Bass/Center-Out Port Connector .....	28
Line-Out (Front-Out) Port Connector .....	28
Line-In (Rear-Out) Port Connector .....	29
<b><i>Front-Panel Connectors</i></b>	
ATX Power On/Off Switch Connector (POWER ON) .....	30
HDD LED Connector (HDD LED) .....	30
Green LED / Power LED Connector (GREEN LED/POWER LED) .....	31
Hardware Reset Connector (RESET) .....	31
Extended USB Headers (JP3) .....	32
Front-Panel 1394 Header (JP5) .....	32
Front-Panel Microphone and Line_out Header (JP4) .....	33
<b><i>Internal Peripherals Connectors</i></b>	
Enhanced IDE and Floppy Connector .....	34
<b><i>Other Connectors</i></b>	
ATX Power Supply Connector (CN5 and JP7) .....	35

---

Cooling Fan Connectors for CPU (FAN1), Chipset (FAN2), System (FAN3)	36
Audio CD-IN Connector (CN3) (Black)	36
Wireless Keyboard and Mouse Connectors (JP2)	37
SPDIF Ext/In/Out Headers (JP9/JP10/JP11)	37
CPU temperature LED (D17)	37
<b>3.3 SYSTEM MEMORY CONFIGURATION</b>	<b>38</b>
1. INSTALL MEMORY	38
2. UPGRADE MEMORY	38
<b>4 SOFTWARE UTILITY</b>	<b>39</b>
<b>4.1 Mainboard CD Overview</b>	<b>39</b>
<b>4.2 Install SIS Chipset Driver</b>	<b>40</b>
<b>4.3 Install Audio Driver</b>	<b>41</b>
<b>4.4 Install SIS VGA Driver</b>	<b>42</b>
Install WINNT VGA driver	43
<b>4.5 Install LAN Driver</b>	<b>45</b>
Install WIN98 LAN driver	46
Install WINNT LAN driver	49
<b>4.6 View the User's Manual</b>	<b>51</b>
<b>5 BIOS SETUP</b>	<b>52</b>
<b>5.1 ENTER BIOS</b>	<b>52</b>
<b>5.2 THE MAIN MENU</b>	<b>53</b>
STANDARD CMOS FEATURES	55
ADVANCED BIOS FEATURES	58
ADVANCED CHIPSET FEATURES	62
INTEGRATED PERIPHERALS	65
POWER MANAGEMENT SETUP	68

---

---

PNP/PCI CONFIGURATION .....	72
PC HEALTH STATUS .....	74
FREQUENCY/VOLTAGE CONTROL .....	77
LOAD FAIL-SAFE DEFAULTS .....	78
LOAD OPTIMIZED DEFAULTS .....	78
SET PASSWORD .....	79
SAVE & EXIT SETUP .....	80
EXIT WITHOUT SAVING .....	80

# WHAT'S IN THE MANUAL

---

## Quick Reference

Hardware Installation >> Step-by-Step .....	Page 11
Jumper Settings >> A Closer Look .....	Page 22
Drivers/Software Utilities >> How to Install .....	Page 39
BIOS Setup >> How to Configure .....	Page 52

## About This Manual

For First-Time DIY System Builder .....	Page 6
For Experienced DIY User .....	Page 6
For System Integrator .....	Page 6



# 1 INTRODUCTION

---

## 1.1 To Different Users

### First-Time DIY System Builder

Welcome to the DIY world! Building your own computer system is not as difficult as you may think. To make your first computer DIY experience successful, right from the start, we have designed the **3.1 Hardware Installation** section in a step-by-step fashion for all the first-time DIY system builders. Prior to installation, we also suggest you to read the whole manual carefully to gain a complete understanding of your new Shuttle FS40 mainboard.

### Experienced DIY User

Congratulate on your purchase of the Shuttle FS40 mainboard. You will find that installing your new Shuttle FS40 mainboard is just easy. Bundled with an array of onboard functions, the highly-integrated FS40 mainboard provides you with a total solution to build the most stable and reliable system. Refer to sections **3.2 Jumper Settings** and **Chapter 4 Drivers/Software Utilities** to find out how to get the best out of your new mainboard. **Chapter 5 BIOS Setup** also contains the relevant information on how to tune up your system to achieve higher performance.

### System Integrator

You have wisely chosen Shuttle FS40 to construct your system. Shuttle FS40 incorporates all the state-of-the-art technology of the SiS 740 chipset from SiS. It integrates the most advanced functions you can find to date in a compact Flex ATX board.

---

## 1.2 Item Checklist:

Check all items with you FS40 mainboard to make sure nothing is missing.  
The complete package should include:

- ✦ One piece of Shuttle FS40 Mainboard

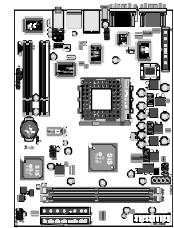

- ✦ One piece of ATA100/66/33 Ribbon Cable



- ✦ One piece of Floppy Ribbon Cable

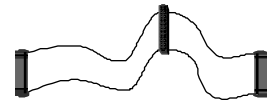

- ✦ One piece of twin ports USB Cable (**optional**)

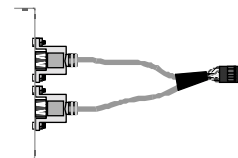

- ✦ One piece of S-Video to AV-Output Cable (**optional**)



- ✦ FS40 User's Manual



- ✦ One piece of Bundled CD-ROM with containing:

- FS40 user's manual saved in PDF format
- SiS Chipset driver
- Hardware Audio driver
- SiS VGA driver
- LAN driver
- Award Flashing Utility

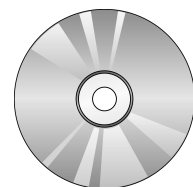

# 2 FEATURES

---

FS40 mainboard is carefully designed for the demanding PC user who wants high performance and maximum intelligent features in a compact package.

## 2.1 Specifications

### \* CPU Support

Support Socket462 package CPU.  
AMD Athlon Processor with 200/266 MHz FSB.  
AMD Duron Processor with 200 MHz FSB.

### \* Chipset

Features SiS 740 N.B. and SiS 961 S.B..

#### **Onboard Lan**

Realtek 8100B, support 10Mb/s and 100Mb/s operation.

#### **Onboard TV-out**

SiS 301, support S-Video and AV Output Signals.

#### **Onboard 1394**

Lucent FW323, support 400Mb/s, 200Mb/s, 100Mb/s data transfer rate.

### \* Jumperless CPU Configuration

Soft-configuration FSB (The FSB speed is software configurable from 100MHz to 133MHz in the Frequency/Voltage Control of BIOS setup program.)

### \* On Board Graphical Controller

The SiS 740 IGUI Host Controller integrates a high performance and high quality 3D/2D Graphical Accelerator.

- Built-in a high performance and high quality 256-bit 3D engine
- Built-in high performance VLIW T/L engine
- Built-in 128 double-words hardware command queue
- Built-in Direct Draw Accelerator
- Built-in GDI+ Accelerator

### \* On Board Multi-Channel Hardware Audio Controller

Support 5.1 speakers, C3DX positional audio in 6 CH speaker mode.  
HRTF-3D positional audio, supporting Direct Sound 3D and A3D interface.  
Legacy SBPRO compatible.

### \* Versatile Memory Support

Two **184-pin DIMM** slots to support up to 1GB of PC1600 or PC2100 compliant **DDR SDRAM** module.

---

## \* PCI Expansion Slots

Provides two 32-bit PCI slots.

## \* 4 USB Interface Onboard

- 2 × USB connectors on back-panel and one sets of dual USB ports headers on mid-board.

## \* I/O Interface

Provides a variety of I/O interfaces:

- 1 × Floppy interface for 3.5-inch FDD with 720KB, 1.44MB, or 2.88MB format or for 5.25-inch FDD with 360K or 1.2MB format.
- 2 × DB9 Serial connectors 16550 UART compatible.
- 1 × Infrared communication port.  
(Serial port COM2 can also be redirected to an external IrDA Adapter for wireless connection.)
- 1 × DB15 VGA connector.
- 1 × AV & S-Video connector.
- 2 × 1394 connectors.
- 1 × RJ45 LAN connector.
- 1 × PS/2 mouse connector.
- 1 × PS/2 Keyboard connector.
- 1 × Line-Out (Front-Out) port.
- 1 × Line-In port, shared with rear speaker output when multi-channel audio is enabled.
- 1 × Bass/Center-Out port.

## \* PCI Bus Master IDE Controller Onboard

Two Ultra DMA **100/66/33** Bus Master Dual-channel IDE ports provide support to a maximum of four IDE devices (one Master and one Slave per channel). The IDE Bus implements data transfer speeds of up to **100/66/33** MB/sec and also supports Enhanced PIO Modes.

80-pin Cable Backward Compatible Legacy ATAPI Devices, ATAPI IDE CD-ROM, CD-R, CD-RW, and LS-120 Supports.

## \* ATX Power Supply Connector

ATX power supply unit can connected to the onboard 20-pin standard ATX power connectors, supporting Suspend and Soft-On/Off by dual-function power button.

The ATX power include other 4-pin +12V ATX power connector.

---

## \* **Advanced Configuration and Power Interface**

Features four power saving modes: S1 (Snoop), S3 (Suspend to RAM), S4 (Suspend to DISK), and S5 (Soft-Off). ACPI provides more efficient Energy Saving Features controlled by your operating system that supports OS Direct Power Management (OSPM) functionality.

## \* **System BIOS**

Provides licensed Award BIOS V6.0 PG on 2Mb Flash core and supports Green PC, Desktop Management Interface (DMI).

## \* **ATX Form Factor**

System board conforms to Flex ATX specification.

Board dimension: 254mm × 185mm.

## \* **Advanced Features**

- **Low EMI** - Built in spread spectrum and automatic clock shut-off of unused PCI/SDRAMS slots to reduce EMI.
- **Dual Function Power Button** - The system can be in one of two states, one is Suspend mode and the other is Soft-Off mode. Pushing the power button for less than 4 seconds places the system into Suspend mode. When the power button is pressed for longer than 4 seconds, the system enters Soft-Off mode.
- **Modem Ring Power-On** - The system can be powered on automatically by the activation of modem ringing.
- **CPU Host/SDRAM/PCI Clock Setting** - This item allows users to adjust CPU Host Clock, SDRAM, and PCI Clock in BIOS.

## \* **Intelligent Features**

- **Voltage Monitoring** - Monitors various voltages of key elements, such as the CPU, and other critical system voltage levels to ensure stable current passing through mainboard components.
- **Fan Status Monitoring** - To prevent CPU from overheating, the CPU fan is monitored for RPM and failure. (CPU Cooling FAN with RPM sensor is required.)
- **Temperature Monitoring** - This item allows users to make sure whether the CPU or system runs in a suitable temperature.

# 3 HARDWARE INSTALLATION

**Before removing or installing any of these devices including CPU, DIMMs, Add-On Cards, Cables, please make sure to unplug the onboard power connector.**

This section outlines how to install and configure your mainboard. Refer to the following mainboard layout to help you to identify various jumpers, connectors, slots, and ports. Then follow these steps designed to guide you through a quick and correct installation of your system.

## 3.1 Step-by-Step Installation

### Accessories Of FS40

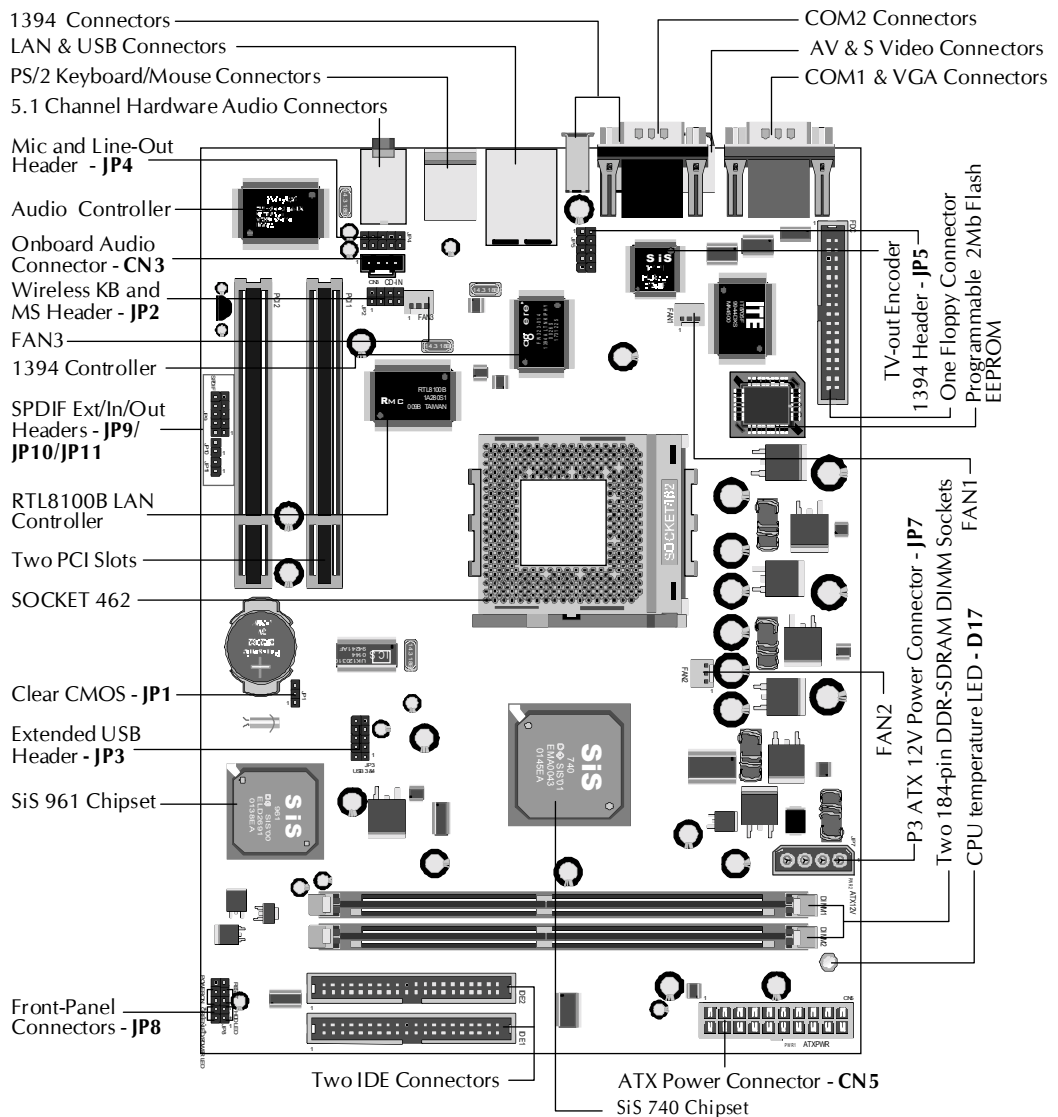

---

## Step 1

### Install the CPU:

1. Locate the CPU ZIF (Zero Insertion Force) socket on the upper-right sector of your mainboard (between the back-panel connectors and the DIMM memory slots).
2. Pull the CPU ZIF socket lever slightly sideways away from the socket to unlock the lever, and then bring it to an upwardly vertical position.
3. Place your AMD 462 Athlon/Duron processor in the socket A. Note that the CPU's edges have been purposely designed non-symmetrically to prevent from inserting the processor in the wrong direction. The following diagram demonstrates the correct placement of the CPU in the ZIF socket. You can see that the two blunt-edged corners should face towards the socket-lever.

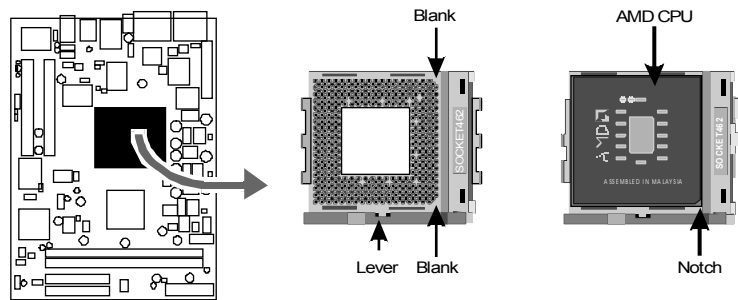

4. Slightly push the AMD 462 Athlon/Duron processor into the socket without applying excessive force while making sure there is no gap between CPU and socket. Then lower the socket-lever all the way down to its horizontal position and lock it to secure the CPU in place.
5. The AMD 462 Athlon/Duron processor requires a set of heatsink/fan to ensure proper cooling of the processor. If heatsink/fan have not been already mounted on your CPU, you must purchase the heatsink/fan separately and have it installed. Plug the cable through the heatsink/fan in the CPU fan power connector located nearby. Note that there are several types of CPU fan connectors. Normally, if your mainboard supports the hardware monitoring function, a 3-pin fan power connector should allow your system to detect the CPU fan's speed. The CPU fan can also run with a 2-pin fan power connector, however, detection of CPU fan's speed is not supported. Another type of CPU fan may feature a large 4-pin fan power connector, which does not support CPU fan's speed detection and must be directly connected to the system's power supply unit. Please refer to the following diagram.

---

## Step 2.

### Set Jumpers

This mainboard is jumperless! The default jumper settings have been set for the common usage standard of this mainboard. Therefore, you do not need to reset the jumpers unless you require special adjustments as any of the following cases:

Clear CMOS

For first-time DIY system builders, we recommend that you do not change the default jumper settings if you are not totally familiar with the mainboard configuration procedures. The factory-set default settings are tuned for optimum system performance. For the advanced users who wish to customize their system, section **3.2 Jumper Settings** will provide detailed information on how to configure your mainboard manually.

## Step 3

### Install DDR SDRAM System Memory

To install memory, insert DDR SDRAM memory module(s) in DIMM slot(s). Note that DDR SDRAM modules are directional and will not go in the DIMM slots unless properly oriented. After the module is fully inserted into the DIMM slots, lift the clips of both sides of the DIMM slot to lock the module in place.

#### DDR SDRAM

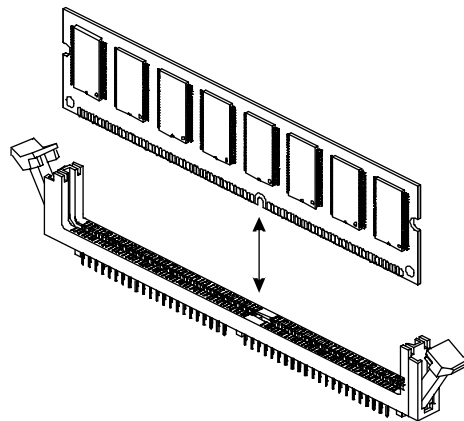



---

## **Step 4**

### **Install Internal Peripherals in System Case**

Before you install and connect the mainboard into your system case, we recommend that you first assemble all the internal peripheral devices into the computer housing, including but not limited to the hard disk drive (IDE/HDD), floppy disk drive (FDD), CD-ROM drive, and ATX power supply unit. This will greatly facilitate in making the connections to the mainboard described below.

To install IDE & FDD drives, follow this procedure:

1. Set the required jumpers on each device according to the instructions provided by the manufacturer. (IDE devices, HDD, and CD-ROM, have to set jumpers to Master or Slave mode depending on whether you install more than one device of each kind.)
2. Connect IDE cable and FDD cable on the back-panel of the internal peripheral devices to the corresponding headers on board. Note that the cable should be oriented with its colored stripe (usually red or magenta) connected to pin#1 both on the mainboard IDE or FDD connector and on the device as well.
3. Connect an available power cable from your system power supply unit to the back-panel of each peripheral device. Note that the power cable is directional and cannot fit in if not properly positioned.

---

## Step 5

### Mount the Mainboard on the Computer Chassis

1. You may find that there are a lot of different mounting hole positions both on your computer chassis and on the mainboard. To choose correct mounting holes, the key point is to keep the back-panel of the mainboard in a close fit with your system case, as shown below.

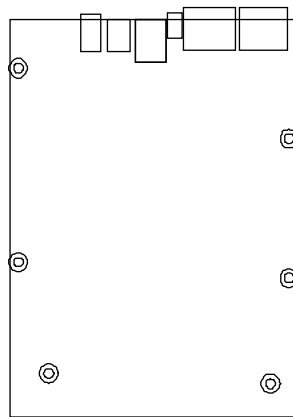

2. After deciding on the proper mounting holes, position the studs between the frame of the chassis and the mainboard. The studs are used to fix the mainboard and to keep a certain distance between the system chassis and the mainboard, in order to avoid any electrical shorts between the board and the metal frame of the chassis. (If your computer case is already equipped with mounting studs, you will need to tighten screws to attach the mainboard.)

**Note:** In most computer housings, you will be able to find 4 or more attachment points to install mounting studs and then fix the mainboard. If there aren't enough matching holes, then make sure to install at least 4 mounting studs to ensure proper attachment of the mainboard.

## Step 6

### Connect Front Panel Switches/LEDs/Speaker/USB

You can find there are several different cables already existing in the system case and originating from the computer's front-panel devices (HDD LED, Power LED, Reset Switch, or USB devices etc.) These cables serve to connect the front-panel switches, LEDs, and USB connectors to the mainboard's front-panel connectors group (JP3 and JP8), as shown below.

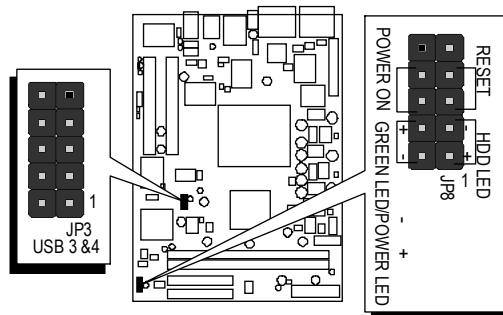

1. ATX Soft Power On/Off (POWER ON)
2. HDD-LED (HDD LED)
3. Green-LED and Power-LED (GREEN LED/POWER LED)
4. Hardware Reset Switch Button (RESET)
5. Extended USB Header

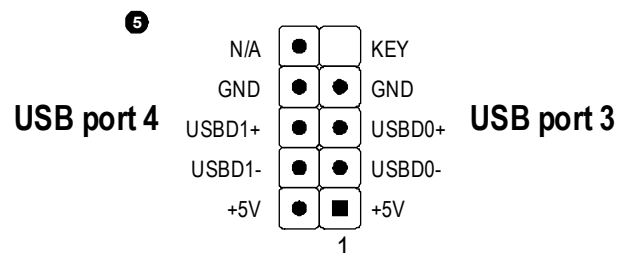
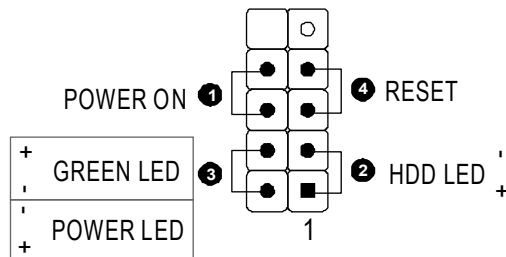

---

## Step 7

### Connect IDE and Floppy Disk Drives

1. IDE cable connector

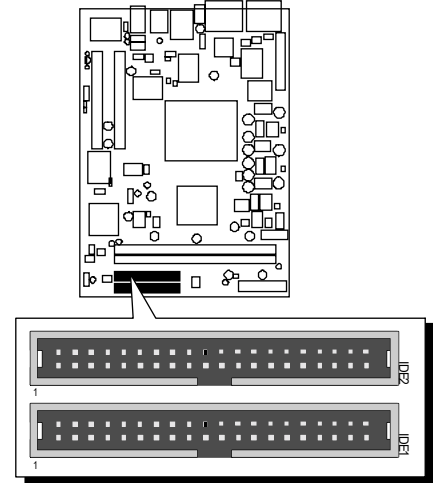

2. Floppy cable connector

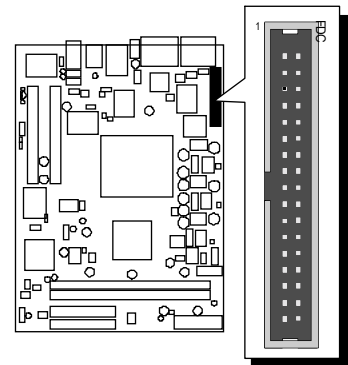

## Step 8

### Connect Other Internal Peripherals

1. CD-IN, Microphone and Line-Out connectors

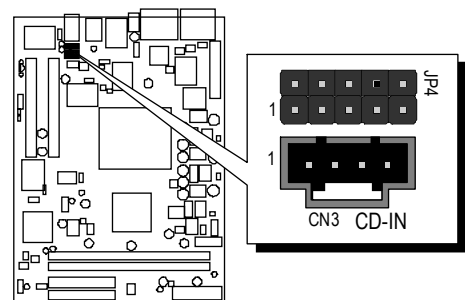

2. 1394 header

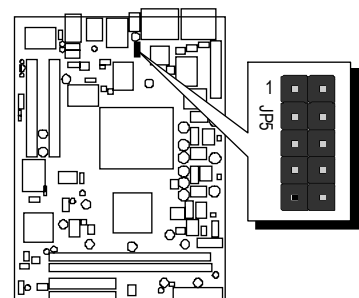

---

3. Wireless keyboard and mouse headers

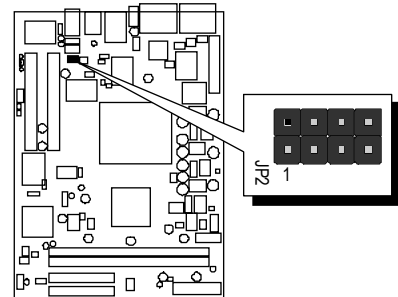

**Step 9**

**Connect the Power Supply**

1. System power connector

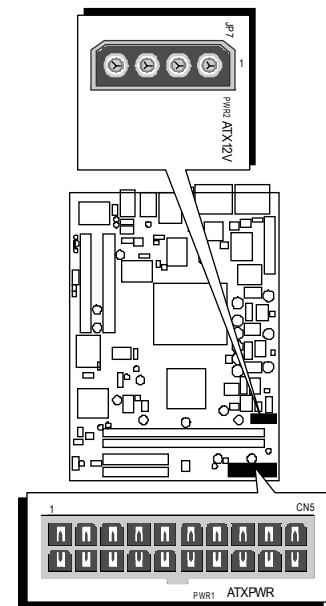

**Step 10**

**Install Add-on Cards in Expansion Slots**

1. PCI Card

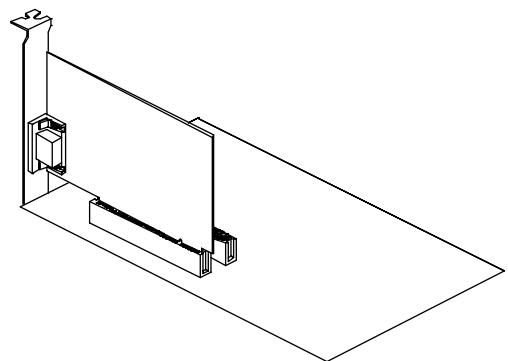

---

## Step 11

### Connect External Peripherals to Back-Panel

You are now ready to put the computer case back together and get on to the external peripherals connections to your system's back-panel.

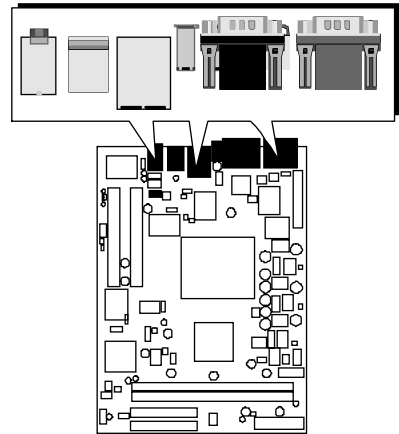

1. COM1 Port
2. COM2 Port
3. VGA Port
4. AV & S Video Port
5. 1394 Ports
6. LAN Port
7. USB1/2 Ports
8. PS/2 Mouse
9. PS/2 Keyboard
10. Audio Line-Out (Front-Out) Port
11. Audio Line-In (Rear-Out) Port
12. Audio Bass/Center-Out Port

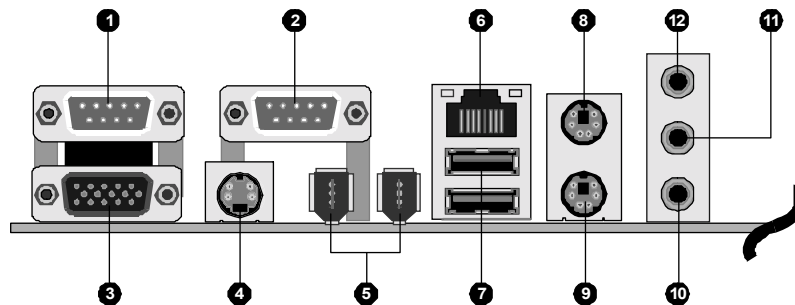

---

## Step 12

### First Time System Boot Up

To assure the completeness and correctness of your system installation, you may check the above installation steps once again before you boot up your system for the first time.

1. Insert a bootable system floppy disk (DOS 6.2x, Windows 95/98/NT, or others) which contains FDISK and FORMAT utilities into the FDD.
2. Turn on the system power.
3. First, you must use the FDISK utility to create a primary partition of the hard disk. You can also add an extended partition if your primary partition does not use all of the available hard disk space. If you choose to add an extended partition, you will have to create one or more logical partitions to occupy all the space available to the extended partition. The FDISK utility will assign a drive letter (i.e., C:, D:, E:,...) to each partition which will be shown in the FDISK program. After FDISK procedure, reboot your system by using the same system floppy disk.

**Note:** DOS 6.2x and Windows 95A can only support up to 2.1GB of HDD partition. If you use the FDISK utility with one of the operating systems mentioned above, you can only install your HDD into partitions no larger than 2.1GB each.

4. Now, use the FORMAT utility to format all the partitions you've created. When formatting the primary partition (C:), make sure to use the `FORMAT C: /S` command.

**Note:** `FORMAT C: /S` can transfer all the necessary system files into the primary partition of your hard disk. Then, your HDD will become a bootable drive.

5. Install all the necessary drivers for CD-ROM, Mouse, etc.
6. Setup the complete operating system according to your OS installation guide.

---

## **Step 13**

### **Install Drivers & Software Components**

Please note that all the system utilities and drivers are designed for Win 9x/2000/ME/XP/NT operating systems only. Make sure your operating system is already installed before running the drivers installation CD-ROM programs.

1. Insert the FS40 bundled CD-ROM into your CD-ROM drive. The autorun program will display the drivers main installation window on screen.
2. Choose "Install SIS Chipset Driver" and complete it.
3. Choose "Install Audio Device Driver" and complete it.
4. Choose "Install VGA Device Driver" and complete it.
5. Choose "Install LAN Driver" and complete it.
6. Exit from the autorun drivers installation program.

☛ Please refer to section **Chapter 4 Software Utility** to install driver.



---

## 3.2 Jumper Settings

Several hardware settings are made through the use of mini jumpers to connect jumper pins on the mainboard. Pin #1 could be located at any corner of each jumper, you just find the location with a white right angle which stands for pin 1#. There are several types of pin 1# shown as below:

3-pin and multi (> 3) pin jumpers shown as following:

Pin #1 to the left:



Pin #1 on the top:





Pin #1 to the right:



Pin #1 on the bottom:



Jumpers with two pins are shown as  for Close [On] or  for Open [Off]. To Short jumper pins, simply place a plastic mini jumpers over the desired pair of pins.

### **Caution!**

1. Do not remove the mainboard from its antistatic protective packaging until you are ready to install it.
2. Carefully hold the mainboard by its edges and avoid touching its components. When putting the mainboard down, place it on top of its original packaging film, on an even surface, and components side up.
3. Wear an antistatic wrist strap or take other suitable measures to prevent electrostatic discharge (ESD) whenever handling this equipment.

---

## Jumpers & Connectors Guide

Use the mainboard layout on page 11 to locate CPU socket, memory banks, expansion slots, jumpers and connectors on the mainboard during the installation. The following list will help you to identify jumpers, slots, and connectors along with their assigned functions:

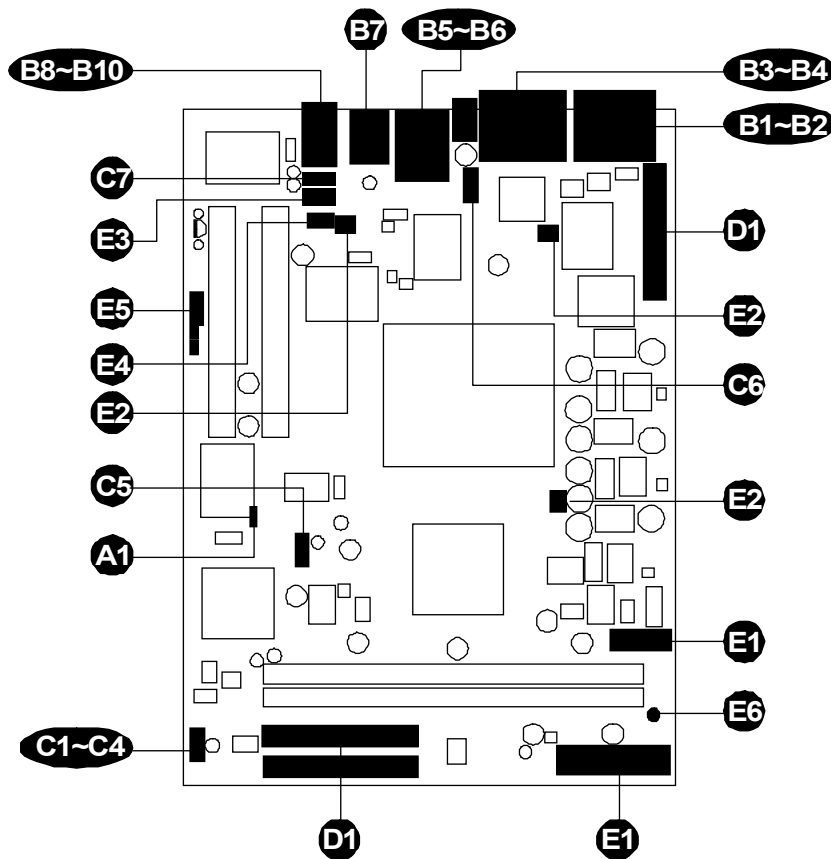

### **CPU/Memory/Expansion Slots**

- |            |   |
|------------|---|
| Socket 462 | : CPU Socket for AMD Athlon and Duron processors.   |
| DIMM1/2    | : Two 184-pin DIMM Slots for 64, 128, 256, 512 MB, and 1 GB of 2.5V DDR SDRAM<br>(The total installed memory does not exceed 2GB) |
| PCI        | : Two 32-bit PCI Expansion Slots  |

---

### **Jumpers**

- Ⓐ1 JP1 : Clear CMOS setting

### **Back Panel Connectors**

- Ⓑ1 COM1/2 : Serial port 1/2 (DB9 male)  
Ⓑ2 VGA : VGA port (DB15 female)  
Ⓑ3 AV & S Video : AV and S Video Ports  
Ⓑ4 1394 : 2 x 1394 (1/2) Ports  
Ⓑ5 LAN : 10/100 base-T LAN Port  
Ⓑ6 USB : 2 USB (1/2) (Universal Serial Bus) ports  
Ⓑ7 MS : PS/2 mouse port  
Ⓑ7 KB : PS/2 keyboard port  
Ⓑ8 BASS/CENTER : Audio Bass/Center-Out Port  
Ⓑ9 LINE-OUT : Audio Line-Out (Front-Out) Port  
Ⓑ10 LINE-IN : Line-In (Rear-Out) Port

### **Front Panel Connectors**

- Ⓒ1 POWER ON : ATX power on/off momentary type switch  
Ⓒ2 HDD LED : IDE drive active LED  
Ⓒ3 GREEN LED/POWER LED : Green LED (ON when system stays in power saving mode)/System power LED  
Ⓒ4 RESET : Hardware reset switch  
Ⓒ5 USB3/4 : Extended USB Header (JP3)  
Ⓒ6 JP5 : Front Panel 1394 header  
Ⓒ7 JP4 : Front-Panel Microphone and Line-out Audio connector

### **Internal Peripherals Connectors**

- Ⓓ1 FDC : Floppy disk drive interface  
Ⓓ1 IDE1 : IDE primary interface (Dual-channel)  
Ⓓ1 IDE2 : IDE secondary interface (Dual-channel)

### **Other Connectors**

- Ⓔ1 CN5/JP7 : ATX power connector  
Ⓔ2 FAN1 : CPU fan connector  
Ⓔ2 FAN2 : Chipset fan connector

- 
- Ⓔ FAN3 : System fan connector
  - Ⓕ CN3 : Audio CD\_IN connector
  - Ⓖ JP2 : Wireless Keyboard and Mouse connector
  - Ⓗ JP9/JP10/JP11 : SPDIF Ext/In/Out connectors
  - Ⓘ D17 : CPU temperature LED

---

## Jumpers

### Clear CMOS Setting (JP1)

JP1 is used to clear CMOS data. Clearing CMOS will result in the permanently erasing previous system configuration settings and the restoring original (factory-set) system settings.



Pin 1-2 (Default)



Pin 2-3 (Clear CMOS)

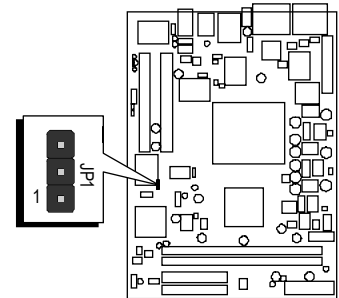

- Step 1.** Turn off the system power (PC-> Off).
- Step 2.** Remove ATX Power cable from ATX Power connector.
- Step 3.** Remove jumper cap from JP1 pins 1-2.
- Step 4.** Place the jumper cap on JP1 pin 2-3 for a few seconds.
- Step 5.** Return the jumper cap to pin 1-2.
- Step 6.** Plug ATX Power cable into ATX Power connector.
- Step 7.** Turn on the system power (PC-> On).

---

## ☛ Back-Panel Connectors

### B1 COM1/2 Port Connectors

This mainboard can accommodate one serial device on COM1/2. Attach a serial device cable to the DB9 serial port COM1/2 at the back-panel of your computer.

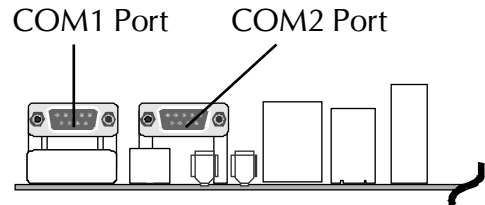

### B2 VGA Connector

One 15-pin VGA connector is located at the rear panel of the mainboard.

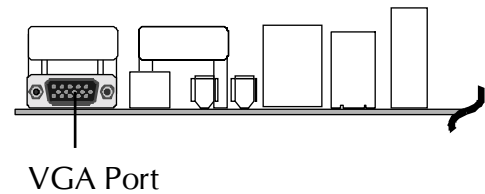

### B3 Optional AV & S Video TV-Out Connectors

This mainboard can accommodate AV and S Video ports on back-panel.

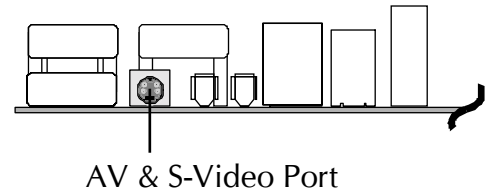

### B4 IEEE 1394 Port Connectors

This mainboard offers two 1394 ports on back-panel. Plug each device jack into an available 1394 connector.

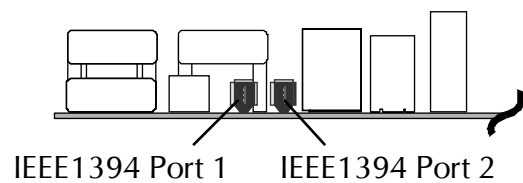

### B5 10/100 base-T LAN Port Connector

This mainboard can accommodate one device on LAN. Attach a RJ45 cable to the LAN port at the back-panel of your computer.

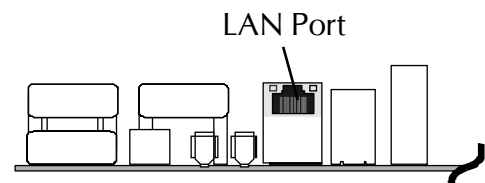

---

### **B6 USB Port 1/2 Connectors**

Two female connectors USB1/USB2 share the same USB (Universal Serial Bus) bracket at the rear panel of your mainboard. Plug each USB device jack into an available USB1/USB2 connector.

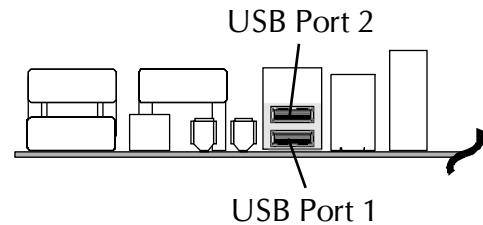

### **B7 PS/2 Keyboard & PS/2 Mouse Connectors**

Two 6-pin female PS/2 keyboard & Mouse connectors are located at the rear panel of the mainboard.

Depending on the computer housing you use (desktop or tower), the PS/2 Mouse connector is situated at the top of the PS/2 Keyboard connector when the mainboard is laid into a desktop, as opposed to a tower where the PS/2 Mouse connector is located at the right of the PS/2 Keyboard's. Plug the PS/2 keyboard and mouse jacks into their corresponding connectors.

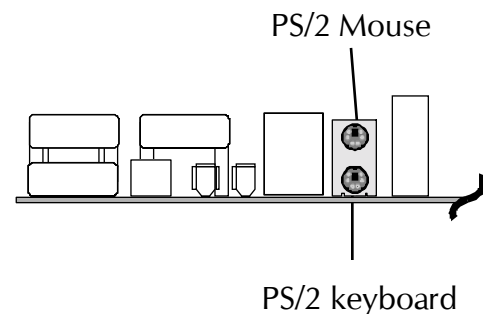

### **B8 Bass/Center-Out Port Connector**

Bass/Center-Out is a stereo output port through which the combined signal of all internal and external audio sources on the board is output. It can be connected to 1/8-inch TRS stereo headphones or to bass/center amplified speakers.

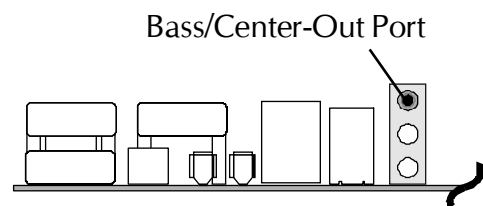

### **B9 Line-Out (Front-Out) Port Connector**

Line-Out is a stereo output port through which the combined signal of all internal and external audio sources on the board is output. It can be connected to 1/8-inch TRS stereo headphones or to amplified speakers.

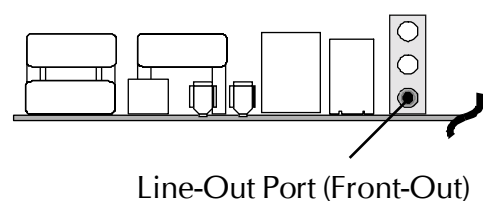

---

**E10 Line-In (Rear-Out) Port Connector**

Line-In is a stereo line-level input port that accepts a 1/8-inch TRS stereo plug. It can be used as a source for digital sound recording, a source to be mixed with the output, or both.

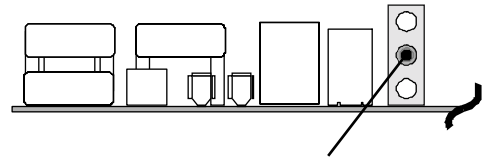

Line-In Port (Rear-Out)



---

## 🔧 Front-Panel Connectors

### ④ ATX Power On/Off Switch Connector (POWER ON)

The Power On/Off Switch is a momentary type switch used for turning on or off the system ATX power supply. Attach the connector cable from the Power Switch to the 2-pin (POWER ON) header on the mainboard.

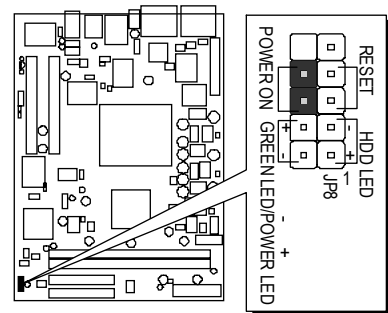

**Note:** Please notice all the LED connectors are directional. If your chassis's LED does not light up during running, please simply change to the opposite direction.

### ⑤ HDD LED Connector (HDD LED)

Attach the connector cable from the IDE device LED to the 2-pin (HDD LED) header. The HDD LED lights up whenever an IDE device is active.

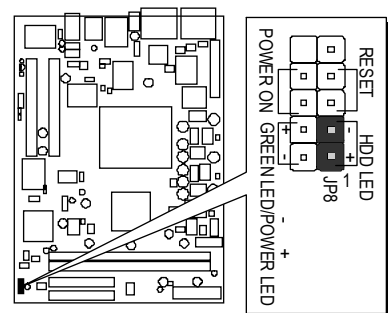

---

### ③ Green LED / Power LED Connector (GREEN LED/POWER LED)

This header is dual color LED function.

Dual color LED function is defined by either Power LED or Green LED, the header can be in these states.

The Green LED indicates that the system is currently in one of the power saving mode (Doze/Standby/Suspend). When the system resumes to normal operation mode, the Green LED will go off, power LED on.

This Power LED will go off during power saving mode.

Attach a 2-pin Green LED/Power LED cable to (GREEN LED/POWER LED) header.

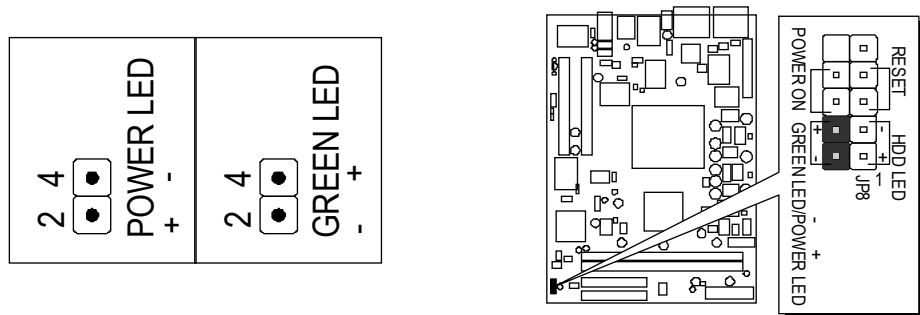

### ④ Hardware Reset Connector (RESET)

Attach the 2-pin hardware reset switch cable to the (RESET) header. Pressing the reset switch causes the system to restart.

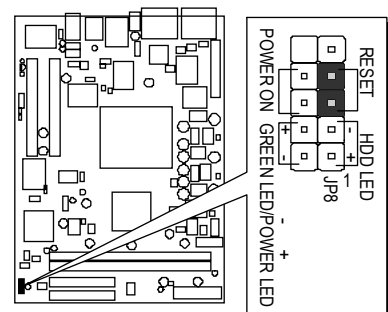

## ⑤ Extended USB Header (JP3)

The headers are used to connect the cable attached to USB connectors which are mounted on front panel or back panel. But the USB cable is optional at the time of purchase.

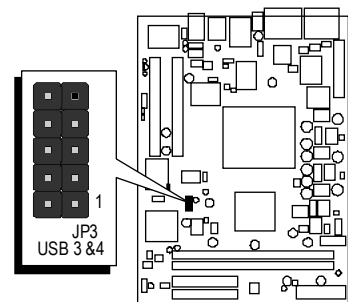
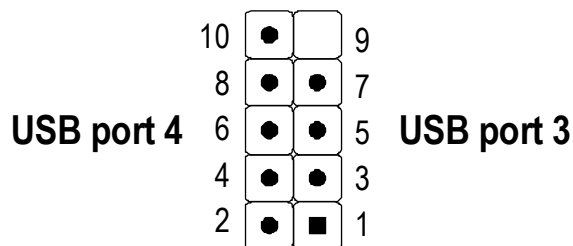

Pins Assignment:

1 = +5V	3 = USBD0-	5 = USBD0+
7 = GND	9 = KEY	
2 = +5V	4 = USBD1-	6 = USBD1+
8 = GND	10 = N/A	

## ⑥ Front-Panel 1394 Header - JP5

The header are used to connect the cable attached to 1394 connector which are mounted on front panel or back panel. But the 1394 cable is optional at the time of purchase.

Pins Assignment:

1 = TPA+	2 = TPA-
3 = GND	4 = GND
5 = TPB+	6 = TPB-
7 = +12V	8 = +12V
9 = KEY	10 = GND

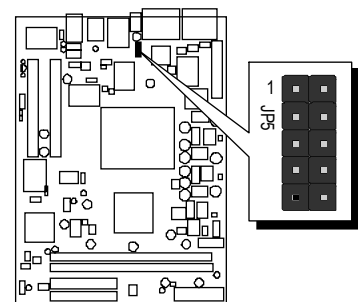
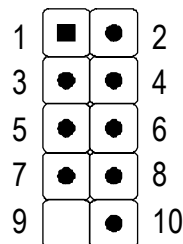

---

## ⑦ Front-Panel Microphone and Line-out Header (JP4)

This header allows users to install auxiliary front-oriented microphone and line-out ports for easier access. Either the Line-out connector on back-panel or JP4 header are available at the same time. If you would like to use this JP4 header on front-panel, please remove all jumpers from JP4 and install your special Extra Mic / Line-out cable instead.

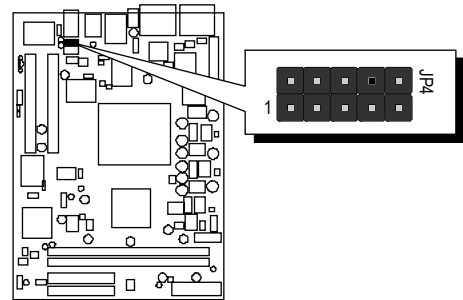
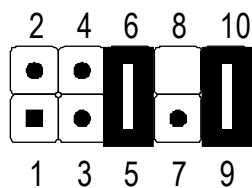

Two mini jumpers must be setted on pin5-6 and pin 9-10, when this header is not used.

### Pins Assignment:

1 = AUD_MIC	2 = AUD_GND
3 = AUD_MIC_VCC	4 = RESERVE
5 = AUD_FRONT_R	6 = AUD_RET_R
7 = HP_ON	8 = KEY
9 = AUD_FRONT_L	10 = AUD_RET_L

---

## ☞ **Internal Peripherals Connectors**

### ① **Enhanced IDE and Floppy Connectors**

The mainboard features two 40-pin dual-channel IDE device connectors (IDE1/IDE2) providing support for up to four IDE devices, such as CD-ROM and Hard Disk Drives (H.D.D.).

This mainboard also includes one 34-pin floppy disk controller (FDC) to accommodate the Floppy Disk Drive (FDD). Moreover, this mainboard comes with one 80-pin ATA **100/66/33** ribbon cable to connect to IDE H.D.D. and one 34-pin ribbon cable for F.D.D. connection.

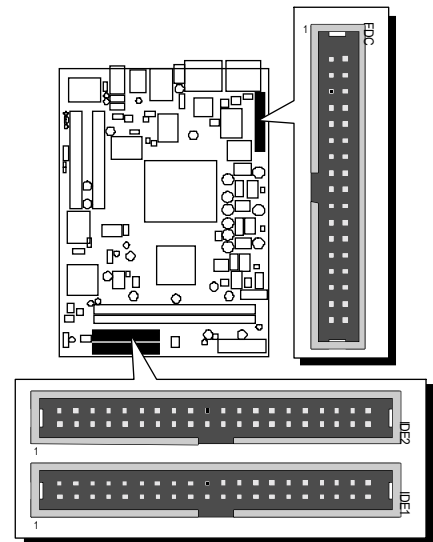

**Important:** Ribbon cables are directional, therefore, make sure to always connect with the red cable stripe on the same side as pin #1 of the IDE1/IDE2 or FDC connector on the mainboard.

## Other Connectors

### ATX Power Supply Connectors (CN5 and JP7)

This motherboard uses 20-pin (CN5) Pentium 4 standard ATX power header, and other JP7 with 1X4-pin + 12V PC ATX power supply headers. Please make sure you plug in the right direction.

P3 ATX Power supply headers

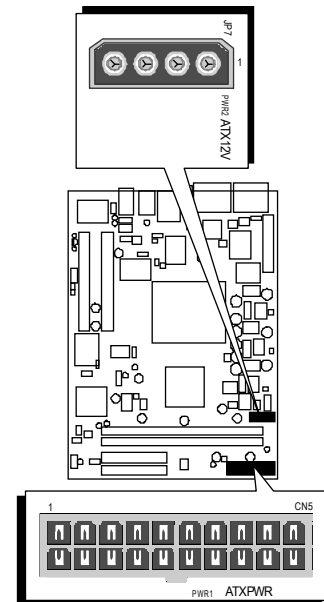
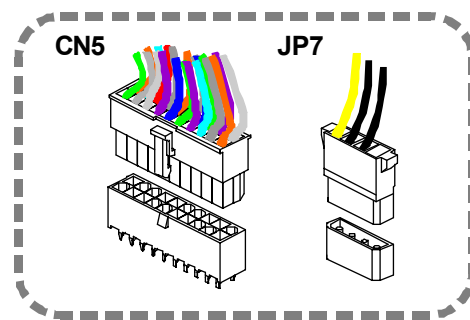

**Note** This motherboard can't support AC power resumes from power failure, you must press power button to power-on.

- Note 1:** The ATX power connector is directional and will not go in unless the guides match perfectly making sure that pin#1 is properly positioned.
- Note 2:** Make sure the latch of the ATX power connector clicks into place to ensure a solid attachment.
- Note 3:** Your ATX power supply must be supplied to ACPI +5V standby power and at least 720mA compatible.
- Note 4:** Make sure your power supply have enough power for higher speed processor installed.

## Ⓔ CPU and System Fan Connectors - FAN1/2/3

The mainboard provides four onboard 12V cooling fan power connectors to support CPU (FAN3), Chipset (FAN2), or System (FAN1) cooling fans.

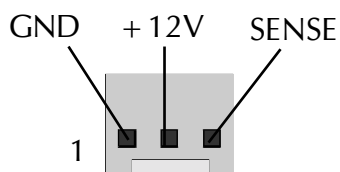

FAN1/2/3 with rotate sense.

### Note:

Both cable wiring and type of plug may vary, which depends on the fan maker. Keep in mind that the red wire should always be connected to the + 12V header and the black wire to the ground (GND) header.

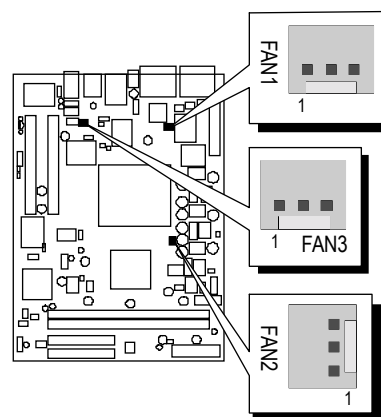

## Ⓕ Audio CD\_IN Connector (CN3) (Black)

Port CN3 is used to attach an audio connector cable from the CD-ROM drive.

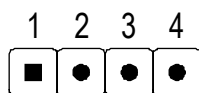

Pin Assignments:

1 = CD-L                      2 = CD-GND  
3 = CD-GND                  4 = CD-R

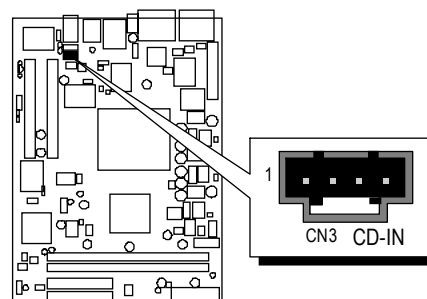

## E4 Wireless Keyboard and Mouse Connector (JP2)

Port JP2 can be used to connect wireless keyboard and mouse device.

Pin Assignments:

1 = +5V	2 = KEY
3 = MS-DT	4 = KB-DT
5 = MS-CK	6 = KB-CK
7 = GND	8 = GND

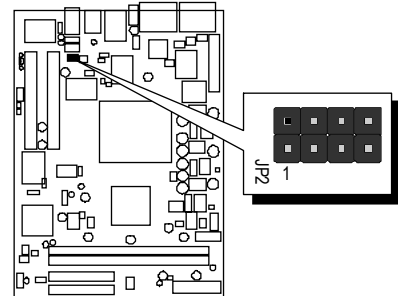
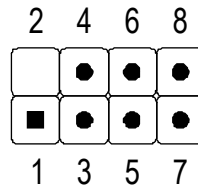

## E5 SPDIF Ext/In/Out Headers (JP9/JP10/JP11)

Port JP9/JP10/JP11 can be used to connect special device.

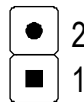
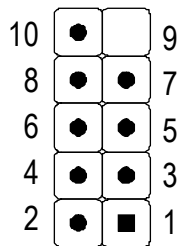

Pin Assignments:

### JP9

1 = +12V	2 = N/A
3 = N/A	4 = SPDIF-OUT
5 = SPDIF-IN 1	6 = GND
7 = SPDIF-IN 2 (optional)	8 = SPGPIO
9 = KEY	10 = GND

### JP10

1 = GND
2 = SPDIF-IN 2 (optional)

### JP11

1 = GND
2 = SPDIF-OUT

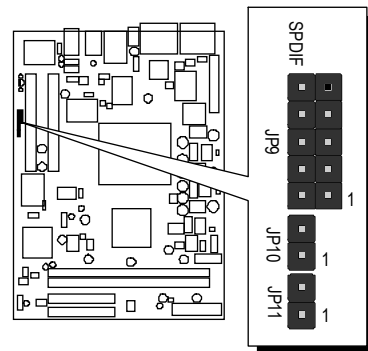

## E6 CPU Temperature LED (D17)

CPU temperature LED will light up only after a system shutdown due to CPU overheat protection. In the event of unexpected system shutdown, please remove the case cover and check the CPU temperature LED.

This function only for Althon XP processor.

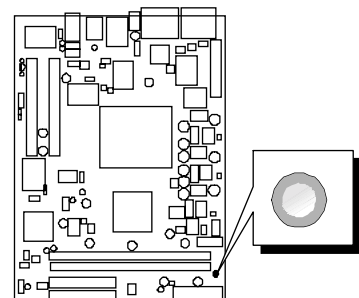



---

### 3.3 System Memory Configuration

The FS40 mainboard has two 184-pin DIMM slots that allow you to install from 64MB up to 1GB of system memory.

Each 184-pin DIMM (Dual In-line Memory Module) Slot can accommodate 64MB, 128MB, 256MB, and 512MB of PC1600/PC2100 compliant 2.5V single (1 Bank) or double (2 Bank) side 64-bit wide data path DDR SDRAM modules.

#### Install Memory:

Install memory in any or all of the slots and in any combination shown as follows.

DIMM Socket	Memory Modules	Module Quantity
DIMM 1	64MB, 128MB, 256MB, 512MB, and 1GB 184-pin 2.5V DDR SDRAM DIMM	x 1
DIMM 2	64MB, 128MB, 256MB, 512MB, and 1GB 184-pin 2.5V DDR SDRAM DIMM	x 1

**Note:** *Maximum installed memory is 1GB.*

**Note:** You do not need to set any jumper to configure memory since the BIOS utility can detect the system memory automatically. You can check the total system memory value in the BIOS Standard CMOS Setup menu.

#### Upgrade Memory:

You can easily upgrade the system memory by inserting additional DDR SDRAM modules in available DIMM slots. The total system memory is calculated by simply adding up the memory in all DIMM slots. After upgrade, the new system memory value will automatically be computed and displayed in the field "Standard CMOS Setup" of BIOS setup program.

# 4 SOFTWARE UTILITY

---

## 4.1 Mainboard CD Overview

**Note:** The CD contents attached in FS40 mainboard are subject to change without notice.

To start your mainboard CD disc, just insert it into your CD-ROM drive and the CD AutoRun screen should appear. If the AutoRun screen does not appear, double click or run D:\Autorun.exe (assuming that your CD-ROM drive is drive D:)

### Navigation Bar Description:

- ☞ **Install SIS Chipset Driver** - Installing SIS chipset driver.
- ☞ **Install Audio Device Driver** - Installing Hardware Audio driver.
- ☞ **Install VGA Device Driver** - Installing SIS VGA driver.
- ☞ **Install LAN Driver** - Installing LAN driver.
- ☞ **Manual** - FS40 Series mainboard user's manual in PDF format.
- ☞ **Link to Shuttle Homepage** - Link to shuttle website homepage.
- ☞ **Browse this CD** - Allows you to see contents of this CD.
- ☞ **Quit** - Close this CD.

⚙ The NT VGA/LAN Device Driver and Win 9x LAN Device Driver must be installed manually.

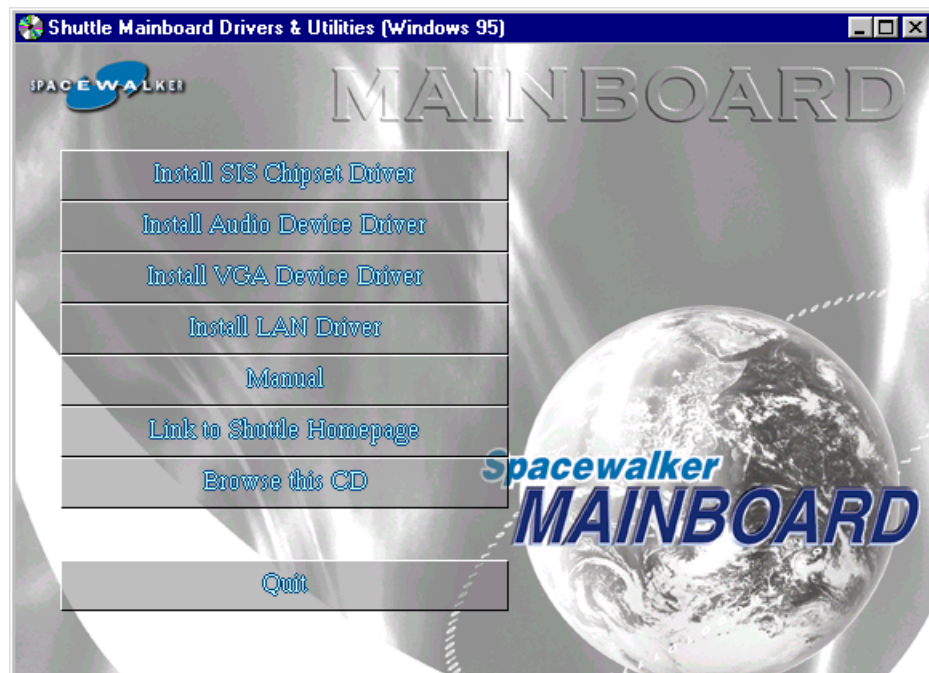

---

## 4.2 Install SIS Chipset Driver

Insert the attached CD into your CD-ROM drive and the CD AutoRun screen should appear. If the AutoRun screen does not appear, double click on Autorun icon in **My Computer** to bring up **Shuttle Mainboard Software Setup** screen.

Select using your pointing device (e.g. mouse) on the “**Install SIS Chipset Driver**” bar to install SIS chipset driver.

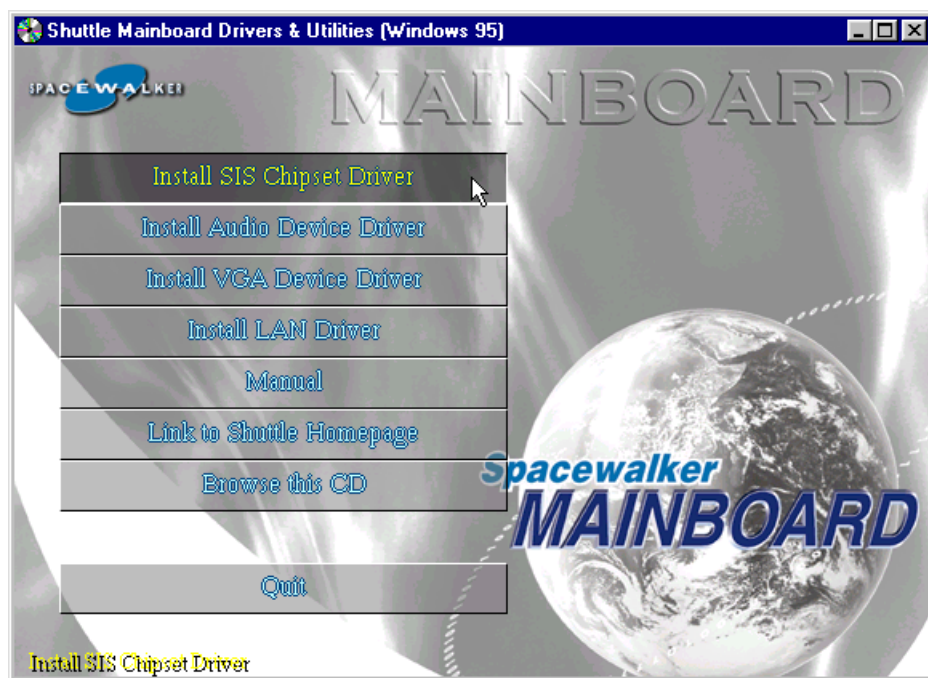

Once you made your selection, a Setup window run the installation automatically.

When the copying files is done, make sure you **reboot** the system to take the installation effect.

**Note:** The win NT don't need install this driver.

---

### 4.3 Install Audio Driver

Insert the attached CD into your CD-ROM drive and the CD AutoRun screen should appear. If the AutoRun screen does not appear, double click on Autorun icon in **My Computer** to bring up **Shuttle Mainboard Software Setup** screen.

Select using your pointing device (e.g. mouse) on the “**Install Audio Device Driver**” bar to install Hardware Audio driver.

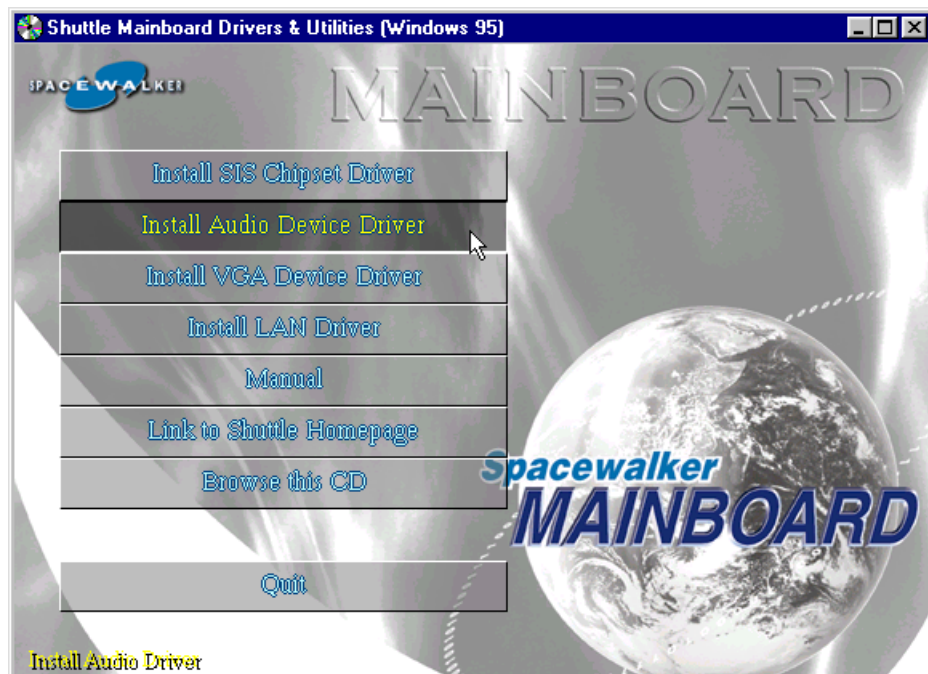

Once you made your selection, a Setup window run the installation automatically.

When the copying files is done, make sure you **reboot** the system to take the installation effect.

---

## 4.4 Install SIS VGA Driver

Insert the attached CD into your CD-ROM drive and the CD AutoRun screen should appear. If the AutoRun screen does not appear, double click on Autorun icon in **My Computer** to bring up **Shuttle Mainboard Software Setup** screen.

Select using your pointing device (e.g. mouse) on the “**Install VGA Device Driver**” bar to install SIS VGA driver.

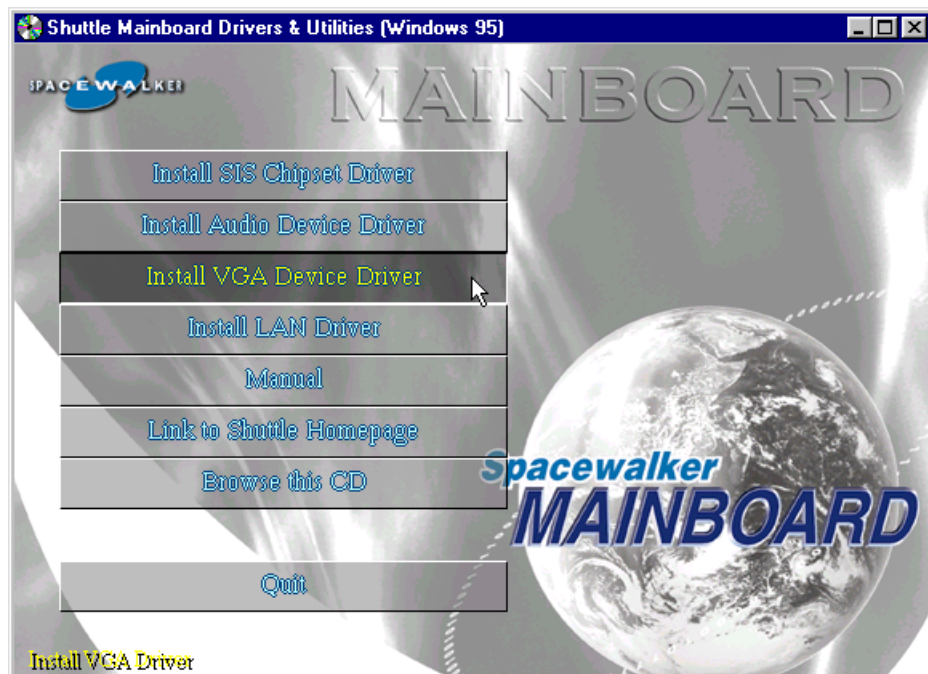

Once you made your selection, a Setup window run the installation automatically.

When the copying files is done, make sure you **reboot** the system to take the installation effect.

**Note:** When Install VGA driver, please confirm your OS and correctly install driver. If your OS is NT, please take the following next page for reference and make sure install the service pack 3 or above. The other OS such as win 2000/XP/9x/ME can be automatical installed.

---

### Install WINNT VGA driver

The VGA Device Driver can't install automatically, you need double click on **My Computer -> Control Panel -> Display** icon to bring up **Display Properties** screen.

Select tab "**Settings**" and "**Display Type**" bar to continue.

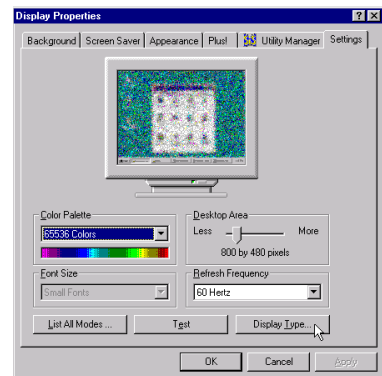

The **Display Type** windows will appear on your screen. Click on "**Change**" bar to install driver.

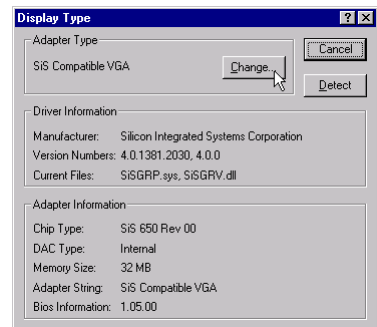

Insert the support CD by the mainboard manufacturer and choose "**Have Disk**" bar to continue next step.

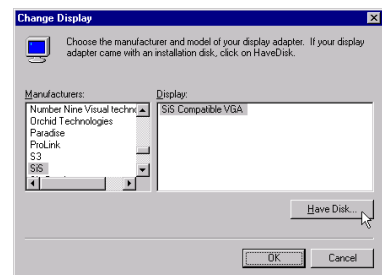

Key in the driver's location as "**D:\VGA\WINNT\SISGR.INF**" (In this location CD disk drive is supposed to be "**D**" letter.) and click on "**OK**".



---

Select **"SiS Compatible VGA"** to install, and then click on **"OK"**.

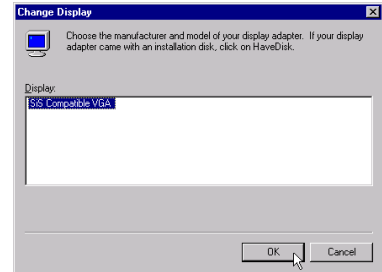

Make sure **"SiS Compatible VGA"** driver, and click on **"Yes"**.

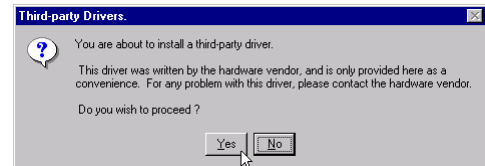

Completing the upgrade device driver, and click on **"OK"** to restart the system to take all the changes effect.

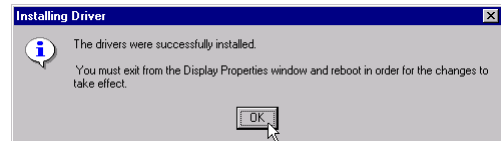

After restart, you may check Display under the location mentioned at right figure. The Display Properties shows correctly.

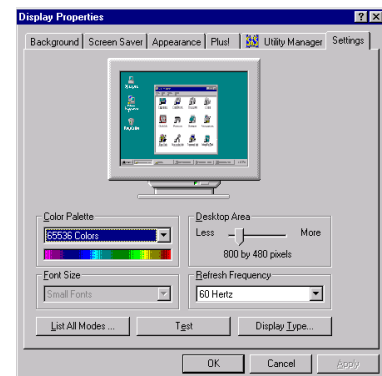

---

## 4.5 Install LAN Driver

Insert the attached CD into your CD-ROM drive and the CD AutoRun screen should appear. If the AutoRun screen does not appear, double click on Autorun icon in **My Computer** to bring up **Shuttle Mainboard Software Setup** screen.

Select using your pointing device (e.g. mouse) on the “**Install LAN Driver**” bar to install LAN driver.

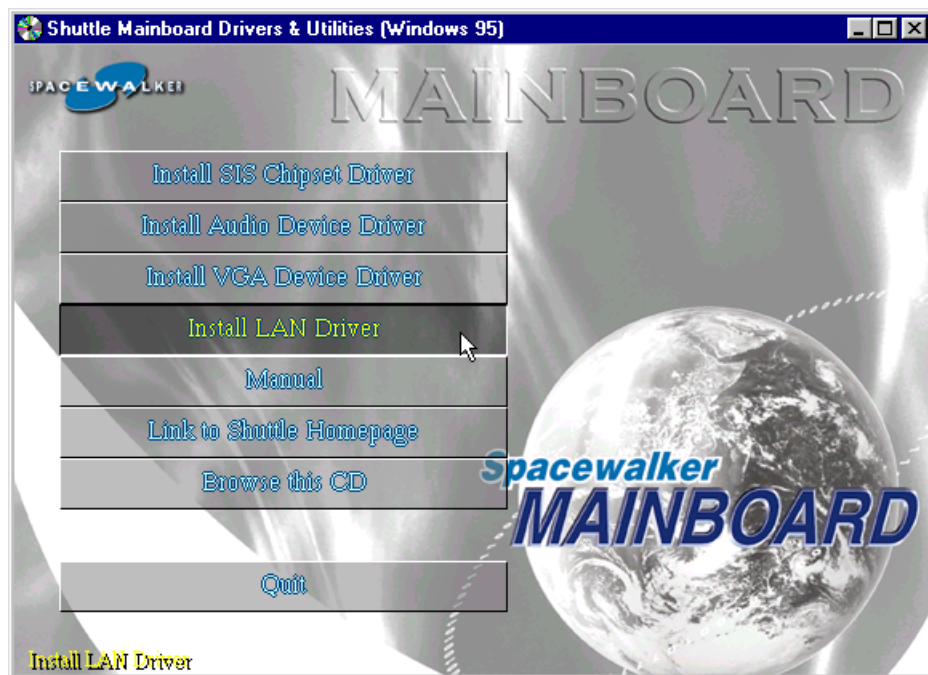

Once you made your selection, a Setup window run the installation automatically.

When the copying files is done, make sure you **reboot** the system to take the installation effect.

**Note:** When Install LAN driver, please confirm your OS and correctly install driver. If your OS is win 9X/NT, please take the following next page for reference. The other OS such as win 2000/XP/ME can be automatical installed



---

## Install WIN98 LAN driver

The LAN Device Driver can't install automatically, you need double click on **My Computer -> Control Panel -> System** icon to bring up **System Properties** screen.

Select tab "**Device Manager**".

You will find a yellow "?" mark at **PCI Ethernet Controller**, that means the driver is not recognize.

Double click on the **Ethernet Controller**.

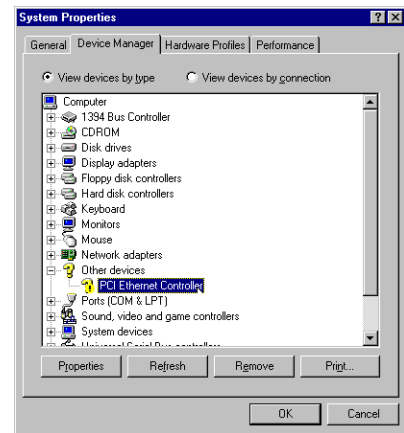

Then **PCI Ethernet Controller Properties** windows will appear on your screen.

Click on the "**Reinstall Driver**" bar to install driver.

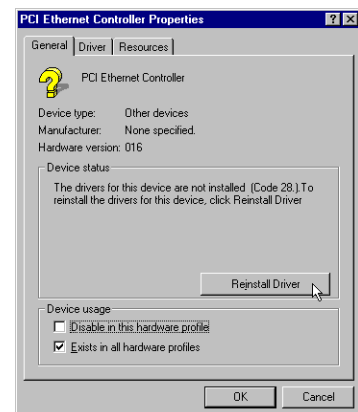

The **Update Device Driver Wizard** windows will appear on your screen.

Click on "**Next**" bar to continue.



---

Please choose **"Display a list of the drivers in a specific location, so you can select the driver you want"** to the manual install driver, and click on **"Next"** bar to continue.



Select **"Network adapters"** bar for LAN device and click on **"Next"** bar to continue.



Insert the support CD by the mainboard manufacturer and choose **"Have Disk"** bar to continue next step.

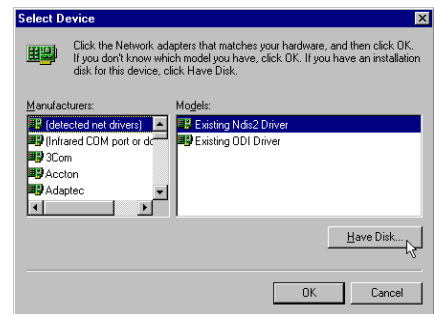

Indicate the driver's location as **"D:\lan\WIN98\NETRTS5.INF"** (In this location CD disk drive is supposed to be **"D"** letter.)

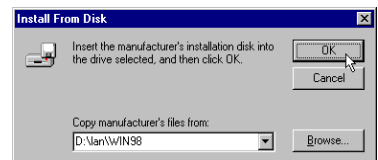

Select "**Realtek RTL8139/810X Family PCI Fast Ethernet NIC**" to install, and then click on "**OK**".

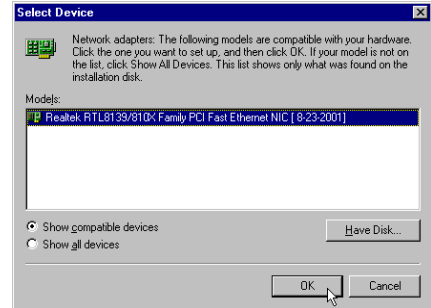

Make sure "**Realtek RTL8139/810X Family PCI Fast Ethernet NIC**" driver, and click on "**Next**".

Then the system will do the setup procedure automatically.



Completing the upgrade device driver, and click on "**Finish**" to restart the system to take all the changes effect.

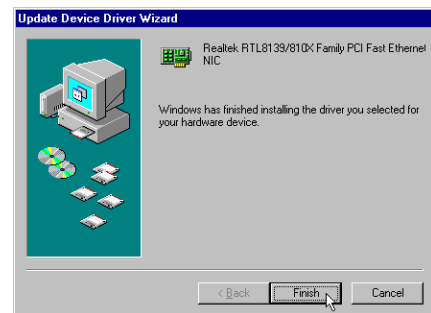

After restart, you may check Network adapters under the location mentioned at right figure.

The Network adapters shows correctly.

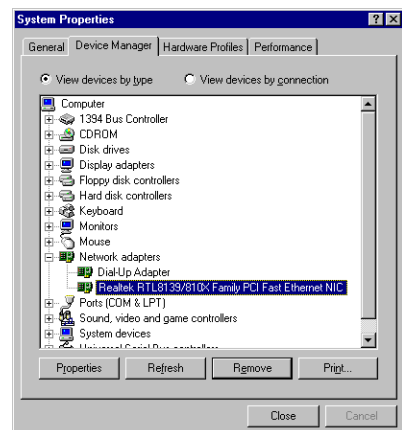

---

### Install WINNT LAN driver

The LAN Device Driver can't install automatically, you need double click on **My Computer -> Control Panel -> Network** icon to bring up **Network** screen.

Select tab "**Adapters**" and "**Add**" bar to install driver.

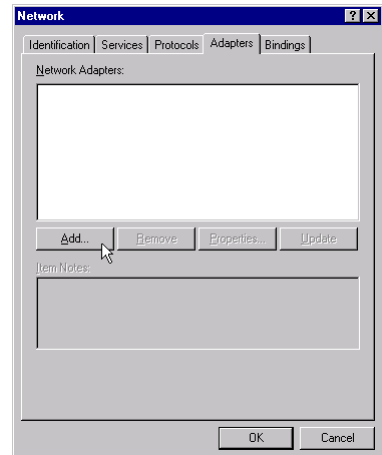

Insert the support CD by the mainboard manufacturer and choose "**Have Disk**" bar to continue next step.

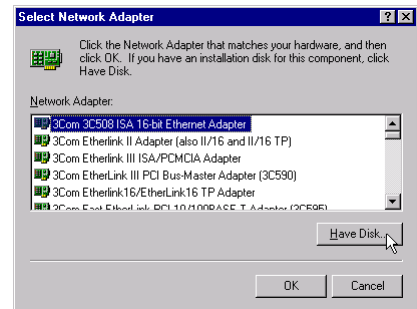

Key in the driver's location as "**D:\lan\WINNT4\**" (In this location CD disk drive is supposed to be "**D**" letter.) and click on "**OK**".

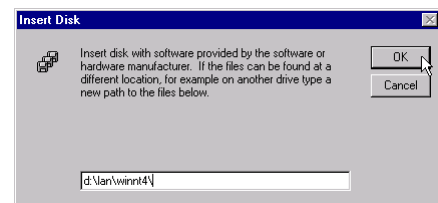

Select "**Realtek RTL8139/810X Family PCI Fast Ethernet Adapter**" to install then click on "**OK**".

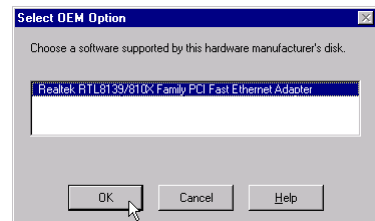

Chose the proper Duplex Mode, and click on "**OK**".

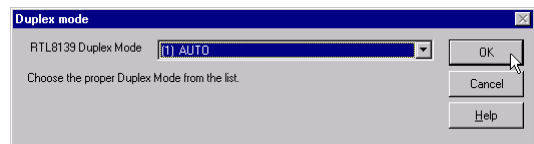

Make sure "**Realtek RTL8139/810X Family PCI Fast Ethernet Adapter**" driver, and click on "**Close**".

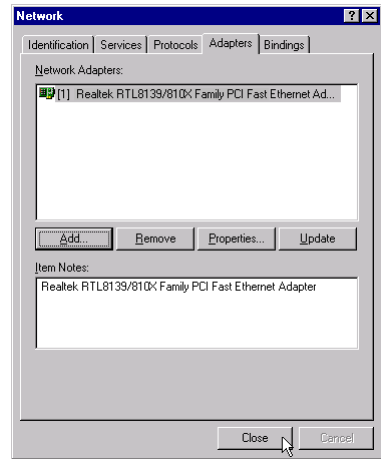

Setting yourself network.  
Then the system will do the setup procedure automatically.

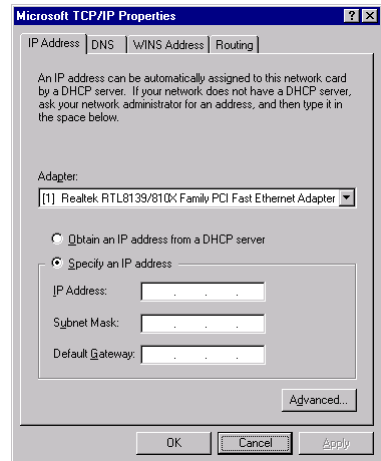

Completing the upgrade device driver, and click on "**Yes**" to restart the system to take all the changes effect.

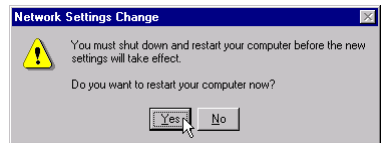

After restart, you may check Network adapters under the location mentioned at right figure. The Network adapters shows correctly.

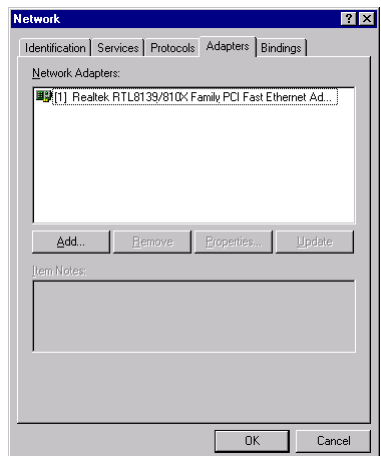

---

## 4.6 View the User's Manual

Insert the attached CD into your CD-ROM drive and the CD AutoRun screen should appear. If the AutoRun screen does not appear, double click on AutoRun icon in **My Computer** to bring up **Shuttle Mainboard Software Setup** screen.

Select using your pointing device (e.g. mouse) on the **"Manual"** bar.

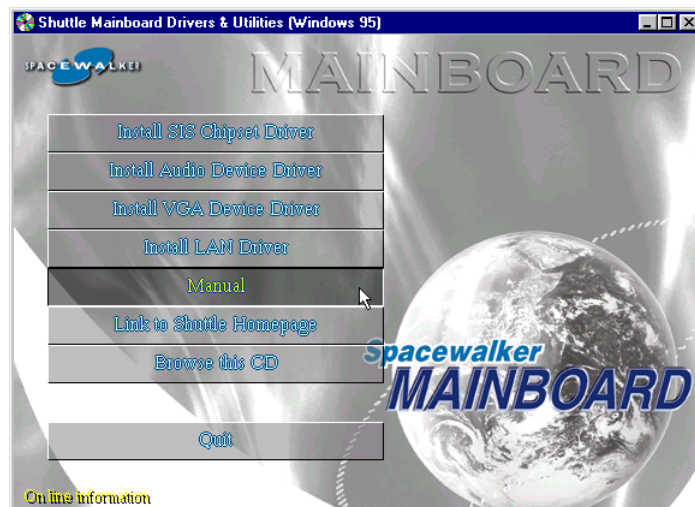

Then **Online Information** windows will appear on your screen. Click on the **"Install Acrobat Reader"** bar if you need to install acrobat reader.

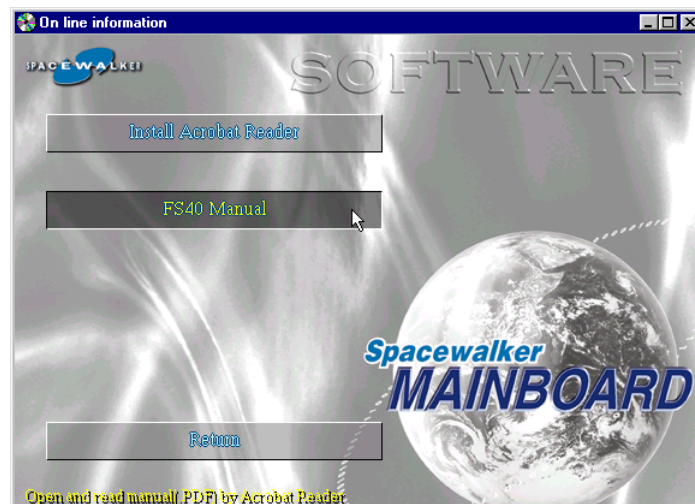

Then click on **"FS40 Manual"** bar to view user's manual.

# 5 BIOS SETUP

---

FS40 BIOS ROM has a built-in Setup program that allows users to modify the basic system configuration. This information is stored in battery-backed RAM so that it retains the Setup information even if the system power is turned off.

The system BIOS is managing and executing a variety of hardware related functions in the system, including:

System date and time

Hardware execution sequence

Power management functions

Allocation of system resources

## 5.1 Enter the BIOS

To enter the BIOS (Basic Input / Output System) utility, follow these steps:

- Step 1.** Power on the computer, and the system will perform its POST (Power-On Self Test) routine checks.
- Step 2.** Press <Del> key immediately, or at the following message:  
“Press DEL to enter SETUP”  
,or simultaneously press <Ctrl>, <Alt>, <Esc> keys

**Note 1.** If you miss trains of words meationed in step2 (the message disappears before you can respond) and you still wish to enter BIOS Setup, restart the system and try again by turning the computer OFF and ON again or by pressing the <RESET> switch located at the computer’s front-panel. You may also reboot by simultaneously pressing the <Ctrl>, <Alt>, <Del> keys.

**Note 2.** If you do not press the keys in time and system does not boot, the screen will prompt an error message, and you will be given the following options:

**“Press F1 to Continue, DEL to Enter Setup”**

- Step 3.** As you enter the BIOS program, the CMOS Setup Utility will prompt you the Main Menu, as shown in the next section.

---

## 5.2 The Main Menu

Once you enter the AwardBIOS(tm) CMOS Setup Utility, the Main Menu will appear on the screen. The Main Menu allows you to select from several setup functions and two exit choices. Use the arrow keys to select among the items and press <Enter> to accept and enter the sub-menu.

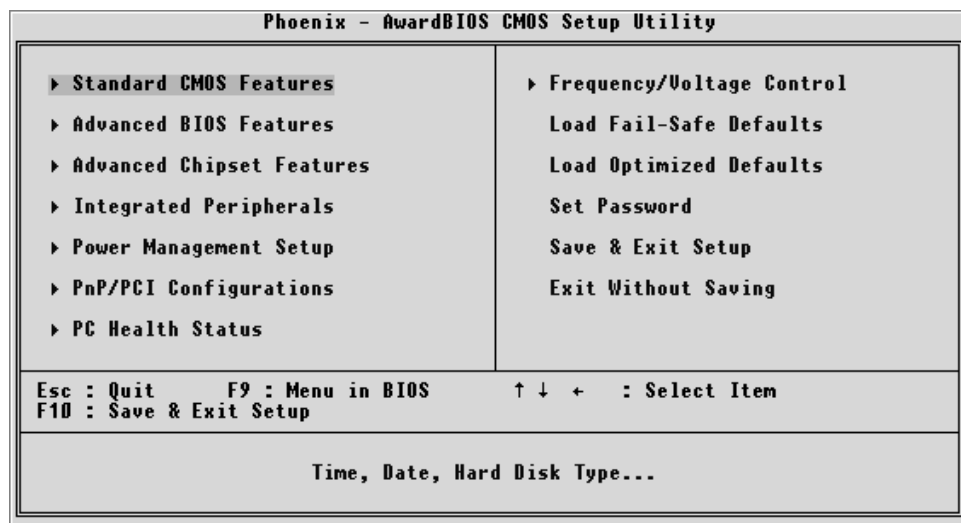

Note that a brief description of each highlighted selection appears at the bottom of the screen.

### **Setup Items**

The main menu includes the following main setup categories. Recall that some systems may not include all entries.

### **Standard CMOS Features**

Use this menu for basic system configuration.

### **Advanced BIOS Features**

Use this menu to set the Advanced Features available on your system.

### **Advanced Chipset Features**

Use this menu to change the values in the chipset registers and optimize your system's performance.

### **Integrated Peripherals**

Use this menu to specify your settings for integrated peripherals.

### **Power Management Setup**

Use this menu to specify your settings for power management.



---

### ***PnP / PCI Configurations***

This entry appears if your system supports PnP / PCI.

### ***PC Health Status***

This entry shows the current system temperature, Voltage, and FAN speed.

### ***Frequency/Voltage Control***

Use this menu to specify your settings for frequency/voltage control.

### ***Load Fail-Safe Defaults***

Use this menu to load the BIOS default values for the minimal/stable performance of your system to operate.

### ***Load Optimized Defaults***

Use this menu to load the BIOS default values that are factory-set for optimal performance system operation. While Award has designed the custom BIOS to maximize performance, the factory has the right to change these defaults to meet users' needs.

### ***Set Password***

Use this menu to change, set, or disable password. It allows you to limit access to the system and Setup, or only to Setup.

### ***Save & Exit Setup***

Save CMOS value changes in CMOS and exit from setup.

### ***Exit Without Saving***

Abandon all CMOS value changes and exit from setup.

---

## **Standard CMOS Features**

The items in Standard CMOS Setup Menu are divided into 10 categories. Each category includes no, one or more than one setup items. Use the arrow keys to highlight the item and then use the <PgUp> or <PgDn> keys to select the value you want in each item.

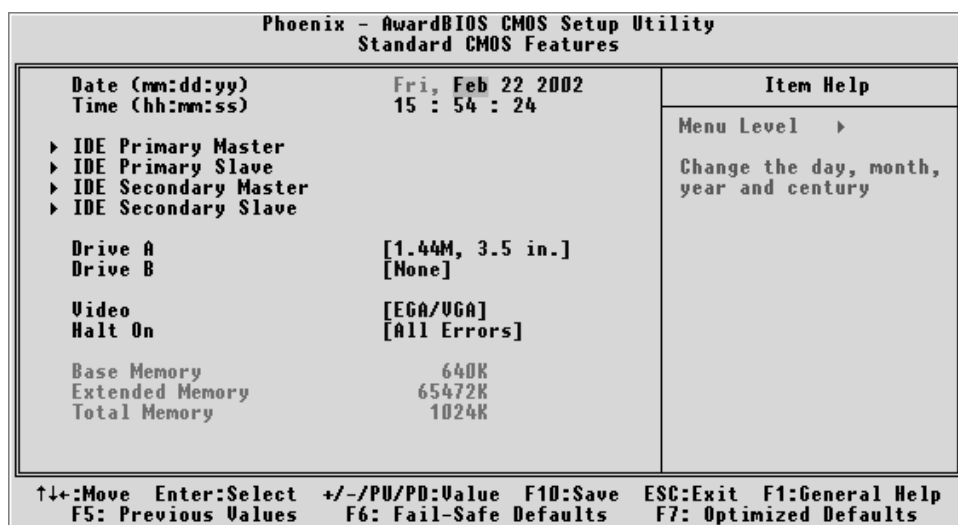

### **Date**

<Month> <DD> <YYYY>

Set the system date. Note that the 'Day' automatically changes when you set the date.

### **Time**

<HH : MM : SS>

The time is converted based on the 24-hour military-time clock. For example, 5 p.m. is 17:00:00.

### **IDE Primary Master**

Options are in its sub-menu.

Press <Enter> to enter the sub-menu of detailed options.

### **IDE Primary Slave**

Options are in its sub-menu.

Press <Enter> to enter the sub-menu of detailed options.

---

### **IDE Secondary Master**

Options are in its sub-menu.

Press <Enter> to enter the sub-menu of detailed options.

### **IDE Secondary Slave**

Options are in its sub menu.

Press <Enter> to enter the sub-menu of detailed options.

### **Drive A/Drive B**

Select the type of floppy disk drive installed in your system.

- The choice: None, 360K, 5.25 in, 1.2M, 5.25 in, 720K, 3.5 in, 1.44M, 3.5 in, or 2.88M, 3.5 in.

### **Video**

Select the default video device.

- The choice: EGA/VGA, CGA 40, CGA 80, or MONO.

### **Halt On**

Select the situation in which you want the BIOS to stop the POST process and notify you.

- The choice: All Errors, No Errors, All, But Keyboard, All, But Diskette, or All, But Disk/Key.

### **Base Memory**

Displays the amount of conventional memory detected during boot up.

- The choice: N/A.

### **Extended Memory**

Displays the amount of extended memory detected during boot up.

- The choice: N/A.

### **Total Memory**

Displays the total memory available in the system.

- The choice: N/A.

\*\*\*\*\*

### **IDE Adapters**

The IDE adapters control the hard disk drive. Use a separate sub-menu to configure each hard disk drive.

#### **IDE HDD Auto-Detection**

Press <Enter> to auto-detect HDD on this channel. If detection is successful, it fills the remaining fields on this menu.

- Press Enter

---

### **IDE Primary Master**

Selecting 'manual' lets you set the remaining fields on this screen and select the type of fixed disk. "User Type" will let you select the number of cylinders, heads, etc., Note: PRECOMP = 65535 means NONE!

- The choice: None, Auto, or Manual.

### **Access Mode**

Choose the access mode for this hard disk.

- The choice: CHS, LBA, Large, or Auto.

### **Capacity**

Disk drive capacity (Approximated). Note that this size is usually slightly greater than the size of a formatted disk given by a disk checking program.

- Auto-Display your disk drive size.

*The following options are selectable only if the 'IDE Primary Master' item is set to 'Manual'*

### **Cylinder**

Set the number of cylinders for this hard disk.

- Min = 0, Max = 65535

### **Head**

Set the number of read/write heads.

- Min = 0, Max = 255

### **Precomp**

Warning: Setting a value of 65535 means no hard disk.

- Min = 0, Max = 65535

### **Landing zone**

Set the Landing zone size.

- Min = 0, Max = 65535

### **Sector**

Number of sector per track.

- Min = 0, Max = 255

\*\*\*\*\*

## **Advanced BIOS Features**

This section allows you to configure your system for basic operation. You have the opportunity to select the system's default speed, boot-up sequence, keyboard operation, shadowing, and security.

Phoenix - AwardBIOS CMOS Setup Utility		Item Help
Advanced BIOS Features		
Virus Warning	[Disabled]	
CPU Internal Cache	[Enabled]	
External Cache	[Enabled]	
Processor Number Feature	[Enabled]	
Quick Power On Self Test	[Enabled]	
First Boot Device	[Floppy]	
Second Boot Device	[HDD-0]	
Third Boot Device	[LS120]	
Boot Other Device	[Enabled]	
Swap Floppy Drive	[Disabled]	
Boot Up Floppy Seek	[Enabled]	
Boot Up NumLock Status	[On]	
Gate A20 Option	[Fast]	
Typematic Rate Setting	[Enabled]	
Typematic Rate (Chars/Sec)	[6]	
Typematic Delay (Msec)	[250]	
Security Option	[Setup]	
APIC Mode	[Enabled]	
MPS Version Control For OS	[1.4]	
OS Select For DRAM > 64MB	[Non-OS2]	
HDD S.M.A.R.T. Capability	[Disabled]	
Report No FDD For WIN 95	[Yes]	
Video BIOS Shadow	[Enabled]	
Small Logo(EPA) Show	[Enabled]	
		Menu Level ▶
		Allows you to choose the VIRUS warning feature for IDE Hard Disk boot sector protection. If this function is enabled and someone attempt to write data into this area , BIOS will show a warning message on screen and alarm beep

↑↓:Move Enter:Select +/-/PU/PD:Value F10:Save ESC:Exit F1:General Help  
F5: Previous Values F6: Fail-Safe Defaults F7: Optimized Defaults

### **Virus Warning**

Allows you to choose the VIRUS Warning feature for IDE Hard Disk boot sector protection. If this function is enables and someone attempts to write data into this area, BIOS will show a warning message on screen, and an alarm beep.

**Enabled** Activates automatically when the system boots up, causing a warning message to appear when anything attempts to access the boot sector or hard disk partition table.

**Disabled** No warning message will appear when anything attempts to access the boot sector or hard disk partition table.

➤ The choice: Enabled or Disabled.

### **CPU Internal Cache**

All processors that can be installed in this mainboard use internal level 1 (L1) cache memory to improve performance. Leave this item at the default value for better performance.

➤ The choice: Enabled or Disabled.

---

### **External Cache**

Most processors that can be installed in this system use external level 2 (L2) cache memory to improve performance. Leave this item at the default value for better performance.

- The choice: Enabled or Disabled.

### **Processor Number Feature**

Allows you to make AMD Processor Serial Number enabled/disabled.

- The choice: Enabled, or Disabled.

### **Quick Power On Self Test**

This item speeds up Power-On Self Test (POST) after you power on the computer. If it is set to enabled, BIOS will shorten or skip some check items during POST.

- The choice: Enabled, or Disabled.

### **First/Second/Third Boot Device**

The BIOS attempts to load the operating system from the devices in the sequence selected in these items.

- The Choice: Floppy, LS120, HDD-0, SCSI, CDROM, HDD-1, HDD-2, HDD-3, ZIP100, LAN, or Disabled.

### **Boot Other Device**

Select Your Boot Device Priority.

- The choice: Enabled or Disabled.

### **Swap Floppy Drive**

If the system has two floppy drives, you can swap the logical drive name assignment.

- The choice: Enabled or Disabled.

### **Boot Up Floppy Seek**

Seeks disk drives during boot-Up. Disabling speed boots up.

- The choice: Enabled or Disabled.

### **Boot Up NumLock Status**

Selects power-on state for NumLock.

- The choice: Off or On.

---

### Gate A20 Option

This entry allows you to select how the gate A20 is handled. The gate A20 is a device used for above 1MByte of address memory. Initially, the gate A20 was handled via a pin on the keyboard. Today, while a keyboard still provides this support, it is more common and much faster in setting to Fast for the system chipset to provide support for gate A20.

- The choice: Normal, or Fast.

### Typematic Rate Setting

Keystrokes repeat at a rate determined by the keyboard controller. When this controller enabled, the typematic rate and typematic delay can be selected.

- The choice: Enabled or Disabled.

### Typematic Rate (Chars/Sec)

This item sets how many times the keystroke will be repeated in a second when you hold the key down.

- The choice: 6, 8, 10, 12, 15, 20, 24, or 30.

### Typematic Delay (Msec)

Sets the delay time after the key is held down before it begins to repeat the keystroke.

- The choice: 250, 500, 750, or 1000.

### Security Option

Select whether the password is required every time the system boots or only when you enter setup.

**System** The system will not boot and access to Setup will be denied if the correct password is not entered promptly.

**Setup** The system will boot, but access to Setup will be denied if the correct password is not entered promptly.

- The choice: System or Setup.

Note: To disabled security, select PASSWORD SETTING at Main Menu, and then you will be asked to enter password. Do not type anything and just press <Enter> ; it will disable security. Once the security is disabled, the system will boot, and you can enter Setup freely.

---

### **APIC Mode**

Selects enable/disable IO APIC function

- The choice: Enabled or Disabled.

### **MPS Version Control For OS**

Selects the operating system multiprocessor support version.

- The choice: 1.1 or 1.4

### **OS Select For DRAM > 64MB**

Selects the operating system that is running with greater than 64MB of RAM in the system.

- The choice: Non-OS2 or OS2.

### **HDD S.M.A.R.T. Capabiliry**

This item enable/disable the HDD system management function.

- The choice: Enabled or Disabled.

### **Report No FDD For Win 95**

Whether report no FDD runs for Win 95 or not.

- The choice: Yes or No.

### **Video BIOS Shadow**

Determines whether video BIOS will be copied to RAM. However, it is optional depending on chipset design. Video Shadow will increase the video speed.

- The choice: Enabled or Disabled.

### **Small Logo(EPA) Show**

This item allows you to enable/disable the EPA Logo.

- The choice: Enabled or Disabled.



---

## **Advanced Chipset Features**

This section allows you to configure the system based on the specific features of the installed chipset. This chipset manages bus speeds and access to system memory resources, such as DRAM and the external cache. It also coordinates communications between the conventional ISA bus and the PCI bus. It states that these items should never need to be altered.

The default settings have been chosen because they provide the best operating conditions for your system. If you discovered that data was being lost while using your system, you might consider making any changes.

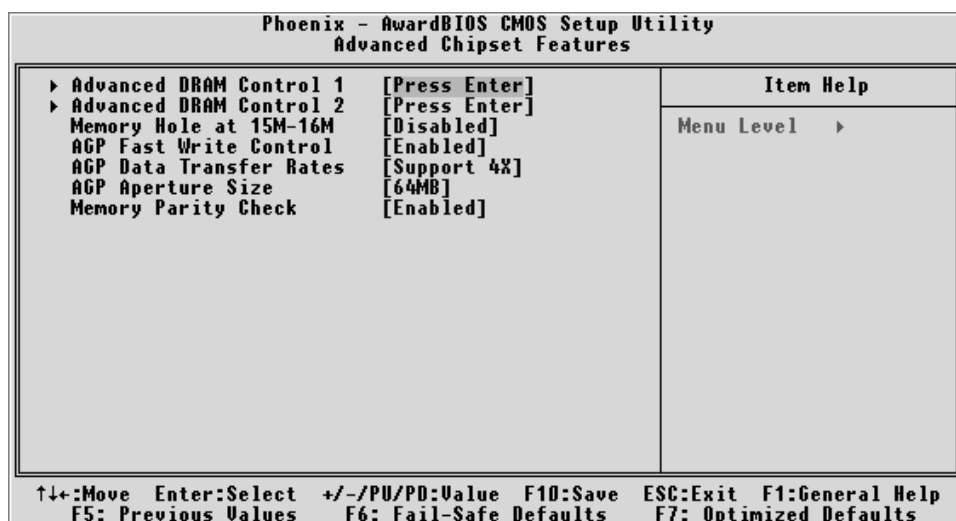

### **Advanced DRAM Control 1**

Options are in its sub-menu.

Press <Enter> to enter the sub-menu of detailed options.

### **Auto Configuration**

This item select the system timing(Safe/Normal/Fast/Ultra) for DDR SDRAM.

➤ The Choice: Safe Mode, Normal Mode, Fast Mode, or Ultra Mode.

### **DDR SDRAM CAS Latency**

This item select the CAS latency for DDR SDRAM.

➤ The Choice: 2T, 2.5T, or 3T.

---

### **CPU/DRAM CLK Synch CTL**

This item allows you set the CPU/DRAM synchronization.

- The Choice: Auto, Synchronous, or Asynchronous.

### **DRAM BackGround Cycles**

This item allows you set the DRAM background cycles.

- The Choice: Auto, Delay 1T, or Normal.

### **LD-OFF Dram RD/WR Cycles**

This item allows you set the LD-Off DRAM RD/WR cycles.

- The Choice: Auto, Delay 1T, or Normal.

### **Advanced DRAM Control 2**

Options are in its sub-menu.

Press <Enter> to enter the sub-menu of detailed options.

### **CS [5:0]# Hold Time CTL**

This item allows you set the CS Hold Time.

- The Choice: + 0.5 ns, + 1.0ns, + 1.5ns, or + 2.0ns.

### **DQS/CSB Hold Time CTL**

This item allows you set the DQS/CSB Hold Time.

- The Choice: + 0.5 ns, + 1.0ns, + 1.5ns, or + 2.0ns.

### **Memory Hole at 15M-16M**

You can reserve this area of system memory for ISA adapter ROM. When this area is reserved, it cannot be cached. The user information of peripherals that need to use this area of system memory usually discusses their memory requirements.

- The Choice: Enabled or Disabled.

### **AGP Fast Write Control**

This item enables an end user to manually select the AGP output buffer drive strength.

- The Choice: Enabled or Disabled.

### **AGP Data Transfer Rates**

This item allows you to select the AGP Mode.

- The Choice: Support 2X or Support 4X.

---

### **AGP Aperture Size**

Select the size of Accelerated Graphics Port (AGP) aperture. The aperture is a portion of the PCI memory address range dedicated to graphics memory address space. Host cycles that hit the aperture range are forwarded to the AGP without any translation.

➤ The Choice: 4M, 8M, 16M, 32M, 64M, 128M, or 256M.

### **Memory Parity Check**

Enabled adds a parity check to the boot-up memory tests. Select Enabled only if the system DRAM contains parity.

➤ The Choice: Enabled or Disabled.

---

## **Integrated Peripherals**

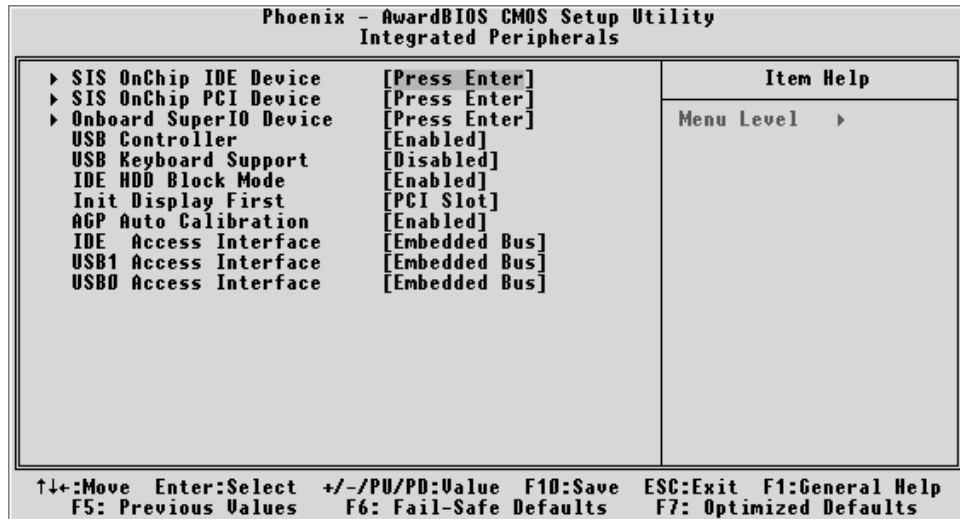

### **SIS OnChip IDE Device**

Options are in its sub-menu.

Press <Enter> to enter the sub-menu of detailed options.

### **Internal PCI/IDE**

This chipset contains an internal PCI IDE interface with support for two IDE channels.

➤ The choice: Disabled, Primary, Secondary, or Both.

### **IDE Primary/Secondary Master/Slave PIO**

The four IDE PIO (Programmed Input/Output) fields let you set a PIO mode (0-4) for each of the four IDE devices that the onboard IDE interface supports. Modes 0 through 4 provide successively increased performance. In Auto mode, the system automatically determines the best mode for each device.

➤ The choice: Auto, Mode 0, Mode 1, Mode 2, Mode 3, or Mode 4.

### **Primary/Secondary Master/Slave UltraDMA**

Ultra DMA/100 implementation is possible only if your IDE hard drive supports it and the operating environment includes a DMA driver (Windows 95 OSR2 or a third-party IDE bus master driver). If both of your hard drive and your system software support Ultra DMA/100, select Auto to enable BIOS support.

➤ The choice: Auto or Disabled.

---

### **IDE Burst Mode**

Selecting Enabled reduces latency between each drive read/write cycle, but may cause instability in IDE subsystems that cannot support such fast performance. If you are getting disk drive errors, try setting this value to Disabled. This field does not appear when the Internal PCI/IDE field, above, is Disabled.

- The choice: Enabled or Disabled.

### **SIS OnChip PCI Device**

Options are in its sub-menu.

Press <Enter> to enter the sub-menu of detailed options.

### **SIS301 Display Type**

This item allows you to control the onboard SiS301 display type.

- The Choice: CRT1 only, CRT1 + A-V PAL OTV, CRT1 + A-V PAL UTV, CRT1 + A-V NTSC OTV, CRT1 + A-V NTSC UTV, CRT1 + S-V PAL OTV, CRT1 + S-V PAL UTV, CRT1 + S-V NTSC OTV, CRT1 + S-V NTSC UTV.

### **Onboard Audio**

This item allows you to control the onboard Hardware Audio.

- The Choice: Enabled or Disabled.

### **Onboard Super IO Device**

Options are in its sub-menu.

Press <Enter> to enter the sub-menu of detailed options.

### **Onboard FDC Controller**

Select Enabled if your system has a floppy disk controller (FDC) installed on the system board and you want to use it. If you install add-on FDC or the system has no floppy drive, select Disabled in this field.

- The choice: Enabled or Disabled.

### **Onboard Serial Port1/Port2**

Select an address and corresponding interrupt for the first and second serial ports.

- The choice: 3E8/IRQ4, 2E8/IRQ3, 3F8/IRQ4, 2F8/IRQ3, Auto, or Disabled.

---

### **USB Controller**

Select Enabled if your system contains a Universal Serial Bus (USB) controller and you have USB peripherals.

- The choice: Enabled or Disabled.

### **USB Keyboard Support**

This item is used to defined USB Keyboard id Enabled or Disabled.

- The Choice: Enabled or Disabled.

### **IDE HDD Block Mode**

The chipset contains a PCI IDE interface with support for two IED channels. Select Enabled to activate the primary and/or secondary IDE interface. Select Disabled to deactivate this interface, if you install a primary and/or secondary add-in IDE interface IDE interface.

- The choice: Enabled or Disabled.

### **Init Display First**

This item is used to determine initial device when system power on.

- The choice: AGP or PCI Slot.

### **AGP Auto Calibration**

This item enable/disable the AGP driving functions.

- The choice: Enabled or Disabled.

### **IDE Access Interface**

This item select the IDE data transfer use PCI bus or Embedded(MuTIOL) bus. The MuTIOL bus is faster.

- The choice: Embedded Bus or PCI Bus.

### **USB1 Access Interface**

This item select the USB1 data transfer use PCI bus or Embedded(MuTIOL) bus. The MuTIOL bus is faster.

- The choice: Embedded Bus, or PCI Bus.

### **USB0 Access Interface**

This item select the USB0 data transfer use PCI bus or Embedded(MuTIOL) bus. The MuTIOL bus is faster.

- The choice: Embedded Bus, or PCI Bus.

---

## Power Management Setup

Phoenix - AwardBIOS CMOS Setup Utility		
Power Management Setup		
ACPI function	[Enabled]	Item Help
ACPI Suspend Type	[S1(POS)]	
Power Management	[User Define]	Menu Level ▶
Suspend Mode	[Disabled]	
Video Off Option	[Susp,Stby -> Off]	
Video Off Method	[DPMS Supported]	
Switch Function	[Break/Wake]	
MODEM Use IRQ	[NA]	
HDD Off After	[Disable]	
Power Button Override	[Instant Off]	
▶ PM Wake Up Events	[Press Enter]	

↑↓=:Move Enter:Select +/-/PU/PD:Value F10:Save ESC:Exit F1:General Help  
F5: Previous Values F6: Fail-Safe Defaults F7: Optimized Defaults

The Power Management Setup allows you to configure your system to most effectively saving energy while operating in a manner consistent with your own style of computer use.

### ACPI Function

This item allows you to enable/disable the Advanced Configuration and Power Management (ACPI)

- The choice: Enabled or Disabled.

### ACPI Suspend Type

This item allows you to select sleep state when suspend.

- The choice: S1(POS) or S3(STR).

### Power Management

This category allows you to select the type (or degree) of power saving mode settings.

**Min Saving** Minimum power management.

Suspend Mode = 1 hr.

**Max Saving** Maximum power management.

Suspend Mode = 1 min.

**User Define** Allows you to set each mode individually.  
Suspend Mode = Disabled or 1 min ~ 1 hr.

- The choice: User Define, Min Saving, or Max Saving.

---

### Suspend Mode

When this item enabled and after the set up time of system inactivity, all devices except the CPU will be shut off.

- The choice: Disabled, 1 Min, 2 Min, 4 Min, 6 Min, 8 Min, 10 Min, 20 Min, 30 Min, 40 Min, or 1 Hour.

### Video Off Option

When enabled, this feature allows the VGA adapter to operate in a power saving mode.

- |                             |  |
|-----------------------------|--|
| <b>Always On</b>            | Monitor will remain on during power saving mode.                           |
| <b>Suspend --&gt; Off</b>   | Monitor is blanked when the system enters the Suspend mode.                |
| <b>Susp,Stby --&gt; Off</b> | Monitor is blanked when the system enters either Suspend or Standby modes. |
| <b>All Modes --&gt; Off</b> | Monitor is blanked when the system enters any power saving mode.           |

- The choice: Always On, Suspend -> Off, Susp,stby -> Off, or All Modes -> Off.

### Video Off Method

This determines the manner in which the monitor is blanked.

- |                         |  |
|-------------------------|--|
| <b>V/H SYNC + Blank</b> | This selection will cause the system to turn off the vertical and horizontal synchronization ports and write blanks to the video buffer. |
| <b>Blank Screen</b>     | This option only writes blanks to the video buffer.  |
| <b>DPMS Supported</b>   | Initial display power management signaling.  |
- The choice: V/H SYNC + Blank, Blank Screen, or DPMS Supported.

### Switch Function

Enables you to set the System Management Interrupt (SMI) button function in DOS.

- The choice: Disabled or Break / wake.

### MODEM Use IRQ

This determines the IRQ which the MODEM can use.

- The choice: 3, 4, 5, 7, 9, 10, 11, or NA.



---

### **HDD Off After**

The IDE hard drive will spin down if it is not accessed within a specified length of time. Options are from 1 Min to 15 Min and Disable.

- The choice: Disabled, 1 Min ~ 15 Min.

### **Power Button Override**

Pressing the power button for more than 4 seconds forces the system to enter the Soft-Off state when the system has "hung."

- The choice: Instant-Off or Delay 4 Sec.

### **PM Wake Up Events**

Options are in its sub-menu.

Press <Enter> to enter the sub-menu of detailed options.

#### **IRQ [3-7, 9-15], NMI**

When enabled, any event occurring at IRQs 3 through 15 (excluding IRQ 8) will awaken a system, which has been powered down.

- The choice: Enabled, Disabled.

#### **IRQ 8 Break Suspend**

This field allows you to enable or disable monitoring of IRQ8 so that it does not awaken the system from a suspend mode.

- The choice: Enabled, Disabled.

#### **RING Power Up Control**

When set to Enabled, the system power will be turned on if there is any modem activity.

- The choice: Enabled, Disabled.

#### **PCIPME Power Up Control**

When set to Enabled, system power will be turned on if there is any PCI card activity from PCI cards that trigger a PME event, such as LAN or Modem cards.

- The choice: Enabled, Disabled.

#### **USB Port Wake Up Control**

This item enable/disable the USB wakeup function.

- The choice: Enabled, Disabled.

---

### **Power Up by Alarm**

When set to Enabled, the following three fields become available and you can set the month, date (day of the month), hour, minute and second to turn on your system.

- The choice: Enabled, Disabled.

### **Month Alarm**

This is for specifying the alarm month which system will awaken the system from suspend mode.

- The choice: NA, 1 ~ 12.

### **Day of Month Alarm**

This item selects the alarm date.

- Key in a DEC number: Min = 1, Max = 31.

### **Time (hh : mm : ss) Alarm**

This item selects the alarm Time.

[hh]

- Key in a DEC number: Min = 0, Max = 23.

[mm/ss]

- Key in a DEC number: Min = 0, Max = 59.

### **\*\*\* Reload Global Timer Events \*\*\***

If any of these items is set to Disabled, system will not monitor the activity event and reload global timer.

If these items is set to Enabled, system will monitor the system activity event; if any of the events it monitored, it will cause system to reload global timer.

These items include Primary IDE0/1, Secondary IDE 0/1, Floppy Disk, Serial Port, Parallel Port, and PCI PIRQ[A-D]#.

- The choice: Disabled or Enabled.

---

## PnP/PCI Configurations

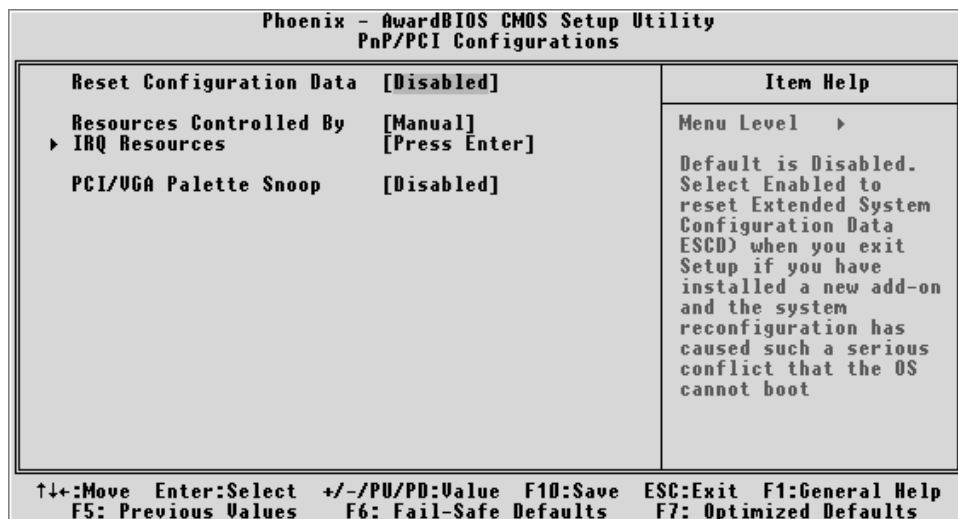

This section describes the configuration of PCI bus system. PCI or Personal Computer Interconnection is a system which allows I/O devices to operate at the speed CPU itself keeps when CPU communicating with its own special components.

This section covers some very technical items, and it is strongly recommended that only experienced users should make any changes to the default settings.

### Reset Configuration Data

Normally, you leave this field Disabled. Select Enabled to reset Extended System Configuration Data (ESCD) when you exit from Setup if you have installed a new device or software and the system reconfiguration has caused such a serious conflict that the operating system can not boot.

- The choice: Enabled or Disabled .

### Resource controlled By

The Award Plug-and-Play BIOS has the capacity to automatically configure all of the boot and Plug-and-Play compatible devices. However, this capability means absolutely nothing unless you are using a Plug-and-Play operating system such as Windows 95.

If you set this field to "manual" , choose specific resources by going into each of the sub-menu that follows this field (a sub-menu is proceeded by a ">").

- The choice: Auto(ESCD) or Manual.

---

### **IRQ Resources**

When resources are controlled manually, assign each system interrupt a type, depending on the type of device using the interrupt.

#### **IRQ3/4/5/7/9/10/11/12/14/15 assigned**

This item allows you to determine the IRQ assigned to the ISA bus and is not available to any PCI slot. Legacy ISA for devices is compliant with the original PC AT bus specification; PCI/ISA PnP for devices is compliant with the Plug-and-Play standard whether designed for PCI or ISA bus architecture.

- The choice: PCI Device or Reserved.

### **PCI/VGA Palette Snoop**

It determines whether the MPEG ISA/VESA VGA Cards can work with PCI/VGA or not. If you have MPEG ISA/VESA VGA Cards and PCI/VGA Card worked, Enable this field. Otherwise, please Disable it.

- The choice: Enabled or Disabled.

---

## PC Health Status

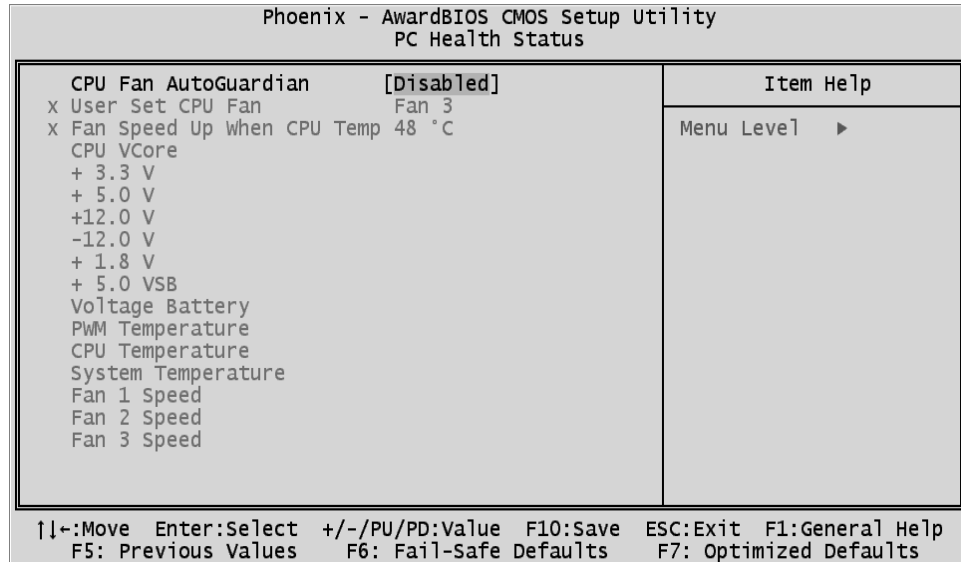

### CPU Fan AutoGuardian

This SMART Bios enables you 3 phase Variable Fan Speed and CPU temperature Control feature.

➤ The choice: Enabled or Disabled.

This feature is controlled via Bios, in which the CPU fan rotational speed sensing/control is governed by CPU temperature setting pre-selected in Bios.

By default, "CPU Fan AutoGuardian" feature under PC Health Status is disabled. To utilize the Smart Bios CPU Fan speed feature please "Enabled" .

**Note:** Before manually modifying the CPU fan settings, please make sure both fan connectors are plug into the correct fan connector designations on the mainboard.

---

Our default for CPU fan cooler is set to Fan 3 and system fan to FAN 1 as shown below.

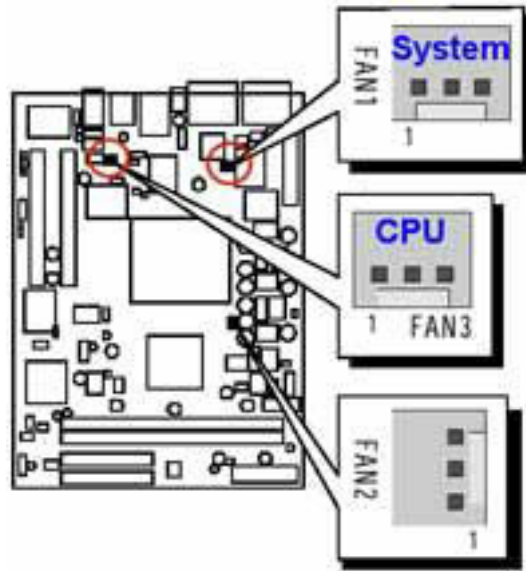

#### User Set CPU Fan

Enable you to choose one or both specific fan for further setting.

- The choice: Fan1, Fan2, Fan3, or Fan1 & Fan3.

#### Fan Speed Up When CPU Temp

Enable 3 phase smart control to the Selected fan. This feature ranges from 40°C to 52°C, in an increment of 4°C. The default temperature is at 48°C.

- The choice: 40°C, 44°C, 48°C, or 52°C.

Take our default Setting for example, 1st and 2nd phase Variable Fan Speed and CPU temperature Control is as defined by "Fan Speed Up When CPU Temp". If actual CPU temp (reported by Bios) stays below 48°C then CPU fan speed will run at a **quiet mode** (1st phase) of approximately 2000 RPM.

But when the actual CPU temp goes above the pre-selected 48°C temperature threshold, then CPU fan speed will automatically engage into **normal mode** (2nd phase) of about 3000 RPM. Automated by the Smart Bios feature, this increase of fan rotation speed will effectively cool down the CPU temperature. And when the CPU temperature drops back below the 48°C temperature threshold, CPU fan speed will again automatically shift back to the quiet mode (1st phase) of about 2000 RPM in order to reduce fan noise level.

---

**Fail-safe mode** (3rd phase) Variable Fan Speed and CPU temperature Control is as predefined at 56°C. Where in the event of system and CPU operating under extreme working conditions, and if CPU temperature is raised above 56°C then the Smart Bios will engage the CPU fan in Fail-safe mode to rotate at about 4500 RPM. Please note that the higher the fan speed, the fan cooler will be become slightly noisier in order to compensate for the increase in CPU temperature.

**Note:** Please disable CPU Fan AutoGuardian feature, if you wish to use other K7 cooler, allowing the CPU fan to run at its default speed.

---

## **Frequency/Voltage Control**

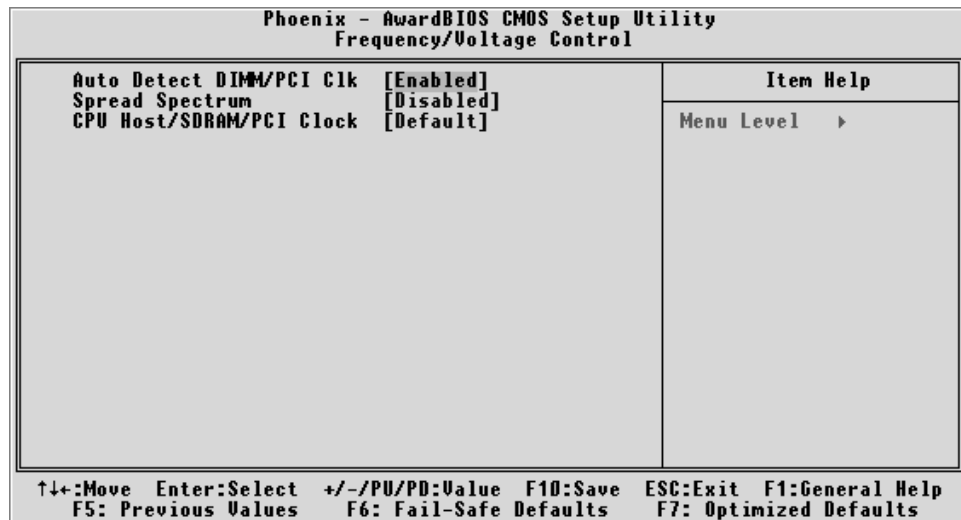

### **Auto Detect DIMM/PCI Clk**

This item allows you to enable/disable auto detection DIMM/PCI Clock.

- The choice: Enabled, or Disabled.

### **Spread Spectrum**

This item allows you to enable/disable the spread spectrum modulation.

- The choice: Enabled, or Disabled.

### **CPU Host/SDRAM/PCI Clock**

This item allows you to adjust CPU/SDRAM/PCI Clock.

- Default, 100/100/33MHz, 100/133/33MHz, 133/100/33MHz, 133/133/33MHz.



---

 **Load Fail-Safe Defaults**

When you press <Enter> on this item, you will get a confirmation dialog box with a message similar to:

Load Fail-Safe Defaults (Y/N) ? N

Pressing 'Y' loads the BIOS default values for the most stable, minimal performance system operations.

 **Load Optimized Defaults**

When you press <Enter> on this item, you will get a confirmation dialog box with a message similar to:

Load Optimized Defaults (Y/N) ? N

Pressing 'Y' loads the default values that are factory-set for optimal performance system operation.

---

## **Set Password**

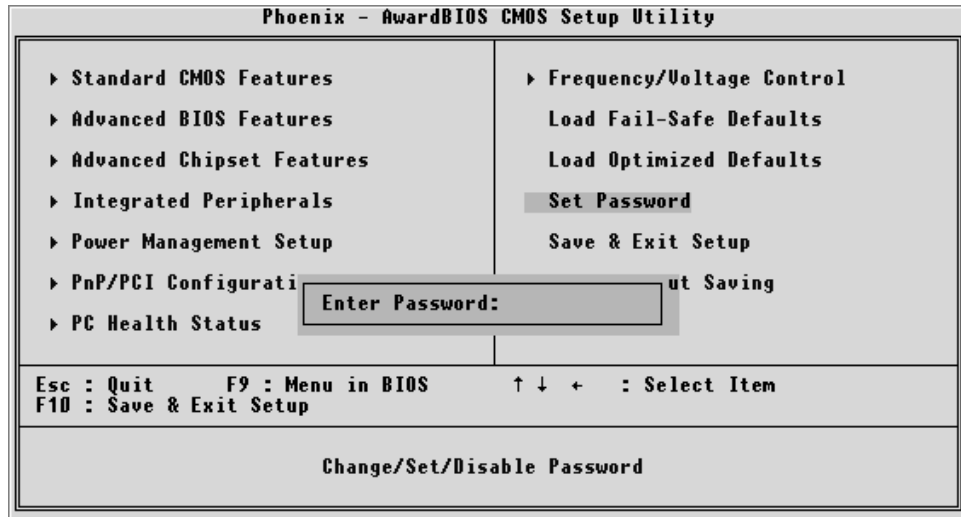

This item is to set supervisor password. Please follow below steps.

### **New Password Setting :**

1. While pressing <Enter> key to start setting password function, a dialog box appears to ask you "Enter password: ".
2. Key in a new password now. However, the password can not be over eight characters or numbers.
3. Then system will request you to confirm new password by asking you to key in new password again.
4. Once the confirmation is completed, new code takes effect.

### **No Password Setting :**

5. If you want to delete password, just press <Enter> key instead of new password while password input is requested. And the other procedures are the same as above password setting.

### **If You Forget Password :**

6. While being asked of password, you just forget it and you must access the system. The only way is to turn off system and clear CMOS memory. Please take reference in page 26 for clear CMOS setting.

---

## **Save & Exit Setup**

Pressing <Enter> on this item asks for confirmation:

Save to CMOS and EXIT (Y/N)? Y

Pressing "Y" stores the selections made in the menus of CMOS - a special section of memory that stays on after you turn your system off. The next time you boot your computer, the BIOS configures your system according to the Setup selections stored in CMOS. After saving the values the system is restarted again.

## **Exit Without Saving**

Pressing <Enter> on this item asks for confirmation:

Quit without saving (Y/N)? Y

This allows you to exit from Setup without storing in CMOS any change. The previous selections remain in effect. This exits from the Setup utility and restarts your computer.